



625 TRENCHER

OPERATOR'S & PARTS MANUAL



PALADIN LIGHT CONSTRUCTION

UNIVERSAL
SKID STEER
APPLICATIONS



SERIAL NUMBER: _____

MODEL NUMBER: _____

Manual Number: OM605
Part Number: 75505
Rev. 3

TABLE OF CONTENTS

625 TRENCHER

TO THE OWNER	A
SAFETY PRECAUTIONS	B
To The Operator	
Before You Start	
During Trencher Operation	
Transporting The Trencher	
Maintaining The Trencher	
INTERNATIONAL SYMBOLS	C
PREOPERATION	D
General Information	
Options	
Trencher Major Component Nomenclature	
MOUNTING KIT INSTALLATION.....	E
Hydraulic Kits	
Optional Hydraulic Side Shift Kits	
Hydraulic Side Shift Kit Mounting Instructions	
TRENCHER INSTALLATION	F
OPERATING INSTRUCTIONS	G
Controls	
Operating Techniques	
TRENCHER ASSEMBLY	I
DIGGING CHAIN OPTIONS	J
MAINTENANCE	L
STORAGE	M
TROUBLE SHOOTING	N
BOLT TORQUE SPECIFICATIONS	O
SPECIFICATIONS	P
DECALS	Q
PREDELIVERY CHECK LIST	R
LIMITED WARRANTY	S

TO THE OWNER

GENERAL COMMENTS

Congratulations on the purchase of your new trencher! Your trencher was carefully designed and manufactured to give you many years of dependable service. Your trencher will require some minor maintenance (such as cleaning and lubricating) to keep it in top working condition. Be sure to observe all safety precautions and maintenance procedures as described in this manual.

ABOUT THIS MANUAL

This manual has been designed to help you do a better, safer job. Read this manual carefully and become familiar with its contents. **Remember, never let anyone operate this trencher without reading the "Safety Precautions" and "Operating Instructions" sections of this manual. (See Sections B and G respectively.)**

Unless noted otherwise, "right-hand" and "left-hand" sides are determined from the position of the skid steer operator sitting in the seat facing forward.

SAFETY ALERT SYMBOL



This is the "Safety Alert Symbol" used by this industry. This symbol is used to warn of possible injury. Be sure to read all warnings carefully. They are included for your safety and for the safety of others working with you.

SERVICE

When servicing your trencher, remember to use only manufacturer replacement parts. Substitute parts may not meet the standards required for safe, dependable operation.

To facilitate parts ordering, record the model and serial number of your trencher in the space provided on this page. This information may be obtained from the trencher identification plate located on the right side of the trencher main frame.

MODEL _____ DATE PURCHASED _____

SERIAL NO. _____

MOUNTED ON _____

Your parts dealer needs this information to insure that you receive the correct parts for your specific trencher.

SAFETY PRECAUTIONS

TAKE NOTE! THIS SAFETY ALERT SYMBOL FOUND THROUGHOUT THIS MANUAL IS USED TO CALL YOUR ATTENTION TO INSTRUCTIONS INVOLVING YOUR PERSONAL SAFETY OR OTHERS. FAILURE TO FOLLOW THESE INSTRUCTIONS CAN RESULT IN INJURY OR DEATH.



THIS SYMBOL MEANS:

ATTENTION!

BECOME ALERT!

YOUR SAFETY IS INVOLVED!

SIGNAL WORDS: Note the use of signal words DANGER, WARNING, and CAUTION with the safety messages. The appropriate signal word for each has been selected using the following guidelines:

DANGER: Indicates an imminently hazardous situation, which if not avoided, will result in death or serious injury. This signal word is to be limited to the most extreme situations, **typically for machine components which, for functional purposes, cannot be guarded.**

WARNING: Indicates a potentially hazardous situation, which if not avoided, could result in death or serious injury, and **includes hazards that are exposed when guards are removed. It may also be used to alert against unsafe practices.**

CAUTION: Indicates a potentially hazardous situation, which if not avoided, **may result in minor or moderate injury. It may also be used to alert against unsafe practices.**

SAFETY PRECAUTIONS

TRENCHERS

GENERAL INFORMATION

This section is composed of various warnings and safety tips. **Read and learn all the information in this section before you attempt to use your trencher.** Also read your vehicle owner's manual before using your equipment. This knowledge will help you operate your unit safely. **Do not take this information lightly, it is presented for your own benefit and for the benefit of others working around you.**

The "Safety Alert Symbol" , as previously described, will be used throughout this manual. It will appear with one of the words **DANGER, WARNING, or CAUTION** above it, and a safety message pertaining to the specific topic being covered. Take the time to read these messages as you come across them.

TO THE OPERATOR

The primary responsibility for safety with the equipment falls to the operator. It is the skill, care, common sense, and good judgment of the operator that will determine how efficiently and safely the job is performed. Know your equipment before you start. Know its capabilities, dimensions, and how to operate all the controls. Visually inspect your equipment before you start, and never operate equipment that is not in proper working order with all safety devices intact.

BEFORE YOU START

1. **Wear the right clothing and gear for the job.** Protective equipment such as hard hat, steel toed shoes, leather gloves, or safety glasses may be in order. They can protect you from needless injury.
2. **Do not wear loose clothing, or things such as rings and watches around the equipment.** They could get caught in moving parts, and lead to serious injury or death.
3. **Know your equipment inside and out.** Know how to operate all controls, and know emergency shutdown procedures. Make sure **all** safety devices are in place and working.
4. **Keep all step plates, grab bars, pedals, and controls free of dirt, grease, and oil.** Keep equipment clean to help avoid injury from a fall when getting on or off equipment.

SAFETY PRECAUTIONS

TRENCHERS

5. **Do not use the trencher or crumber bar as a step, or grab the digging chain when climbing on or off the trencher.** Damage to the equipment or personal injury could result.
6. **Know your work area before you begin.** Observe any potential hazard areas such as soft ground, drop-offs, rocks and other obstacles.
7. **Know where all utility lines are.** Observe overhead electrical and phone lines. Be sure equipment will safely clear them. Know the location of underground cables, wires, gas and water lines, tanks, etc. Contact with electrical lines could cause electrocution. Hitting a gas line or underground tank could cause an explosion.
8. **Be alert to others in the work area.** Be sure others know when and where you will be working. Make sure no one is underneath or behind equipment.
9. **Never try to board equipment while it's moving.**
10. **Always use your seatbelt and safety ROPS (Roll-Over-Protective Structure) that are on the equipment.** They could save your life in the event of a mishap.
11. **Never take passengers on your equipment.** There is no safe place for riders.
12. **Test all controls before you start.** This includes safety equipment and devices.

DURING TRENCHER OPERATION

1. **Be alert to what is going on around you.** Watch for others who may not be watching out for themselves.
2. **Never operate equipment while under the influence of alcohol, or prescription drugs which could inhibit physical and or mental capacity.**
3. **Stop the trencher and shut off the engine if anyone approaches the equipment while it's in motion.** They may not be familiar with the equipment and get in the way of moving parts.
4. **Be alert to changes in the work area.** Changes in weather and soil conditions could turn a safe work site into a hazardous area.

SAFETY PRECAUTIONS

TRENCHERS

5. Keep equipment away from the trencher after it has been dug. The weight of the unit could cause a cave-in.
6. Never drop a boom with a rapidly moving digging chain on the ground. The force of the trencher may cause the vehicle to move suddenly and unexpectedly. Have the chain moving slowly, and lower the boom carefully when starting a new cut.
7. Use caution when digging on a slope. The natural vibration of the trencher will make the unit creep sideways downhill. Try to dig with the trencher in a level position.
8. Never try to make sharp turns while trenching. The trencher boom could become wedged in the trench and damaged.
9. Never attempt to free a stuck chain with the unit running. If the trencher does become jammed, stop the unit and visually inspect the situation.
10. Check the trencher frequently for loose hardware and fittings. The natural vibration of the unit will cause fasteners to loosen during operation.

TRANSPORTING THE TRENCHER

1. Follow all federal, state, and local regulations when transporting the unit on public roads.
2. Use a SMV (Slow Moving Vehicle) sign on the vehicle when transporting. This will help alert others to your presence.
3. Be sure all lights and turn signals are in working order. Use them as required.
4. When parking, park the unit on hard level ground and lower the trencher boom. Block the wheels, and set the parking brake. Shut off the engine.
5. Follow factory recommended shut down procedures for equipment.
6. Stop the trencher and vehicle before dismounting.

SAFETY PRECAUTIONS

TRENCHERS

MAINTAINING THE TRENCHER

1. Replace all safety shields and guards when performing maintenance. Do not operate the trencher with protective equipment removed.
2. Lower the trenching boom, and shut off the engine before working on the unit. Never perform maintenance on a trencher while it is running.
3. Make sure all operating and residual pressures are relieved before working on a hydraulic system. Shut engine off, and operate all the controls to relieve any pressure.
4. Use only manufacturer recommended replacement parts. Other parts may be substandard in fit and quality.
5. Do not set any relief valve higher than recommended by the manufacturer. Relief valves should be checked and adjusted only by a trained service technician. Do not remove or block a relief valve.
6. Observe proper maintenance schedules. Proper maintenance can help prevent a hazardous condition.
7. Always wear safety goggles or glasses when working on equipment.

WARNING! Escaping fluid under pressure can have sufficient force to penetrate the skin, causing serious personal injury. Fluid escaping from a very small hole can be almost invisible. Use a piece of cardboard or wood, rather than hands to search for suspected leaks.



Keep unprotected body parts, such as face, eyes, and arms as far away as possible from a suspected leak. Flesh injected with hydraulic fluid may develop gangrene or other permanent disabilities.

If injured by injected fluid, see a doctor at once. If your doctor is not familiar with this type of injury, ask him to research it immediately to determine proper treatment.

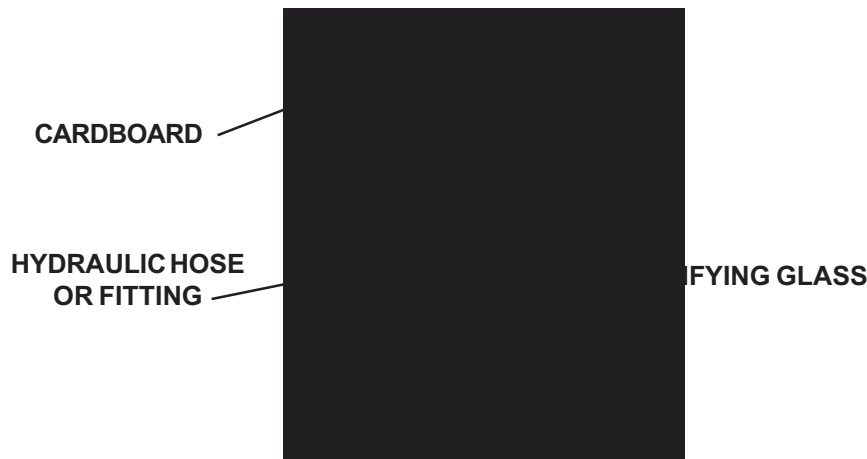

INTERNATIONAL SYMBOLS

As a guide to the operation of your equipment, various international symbols have been utilized on the instruments and controls. The symbols are shown below with an indication of their meaning.

	Engine speed		Alternator charge
	Hours recorded		Power take-off (on)
	Engine water temperature		Power take-off (off)
	Lights		"Tortoise," slow or minimum setting
	Horn		"Hare," fast or maximum setting
	Engine oil pressure		Caution
	Hazard warning		Control lever operating direction
	Axle connect		Rock shaft (raised)
	Axle disconnect		Rock shaft (lowered)
	Continuously variable		Remote cylinder (extended)
	Increase		Remote cylinder (retracted)
	Decrease		Remote cylinder (FLOAT)
	Diesel fuel		Differential lock
	Creeper range		Read operators manual
	High range		Neutral
	Low range		Forward
			Reverse

PREOPERATION

625 TRENCHER

GENERAL INFORMATION

PREPARING THE SKID STEER LOADER

WARNING  Never let anyone operate this skid steer loader and trencher without understanding all of the Safety Precautions and Operating Instructions located in this manual see Sections B and G respectively. Always choose hard level ground to park the skid steer loader on and set the chocks so that the skid steer loader cannot roll.

- MUST

2

2

PREOPERATION

625 TRENCHER

OPTIONS

Eventually you may wish to dig a trench of a depth or width other than what your unit was originally equipped to dig. The 625 trencher can be fitted with optional booms, digging chains, sprockets and crumber assemblies to allow you to dig a variety of different sized trenches with a digging chain option of a tooth every station or every other station. The chart on the following page will give you an idea of the different trench depths and widths a properly equipped unit is capable of digging. For more detailed information on trencher options see Sections I & J of this manual.

TRENCH DEPTHS*	TRENCH WIDTHS			
30" Depth	6.00"	8.00"	10.00"	12.00"
36" Depth	6.00"	8.00"	10.00"	12.00"
42" Depth	6.00"	8.00"	10.00"	NA
48" Depth	6.00"	8.00"	NA	NA
*Trench depths are given with the digging boom at an optimum 65° digging angle and the skid shoe touching the ground. Trenches of various depths can be made by varying the digging angle and raising the trencher up higher. These methods are less efficient however.				

PREOPERATION

TRENCHER MAJOR COMPONENT NOMENCLATURE 625 TRENCHER

GENERAL INFORMATION

The purpose of this page is to acquaint you with the trencher and the names of its various components. This knowledge will be helpful when reading through this manual or when ordering service parts.

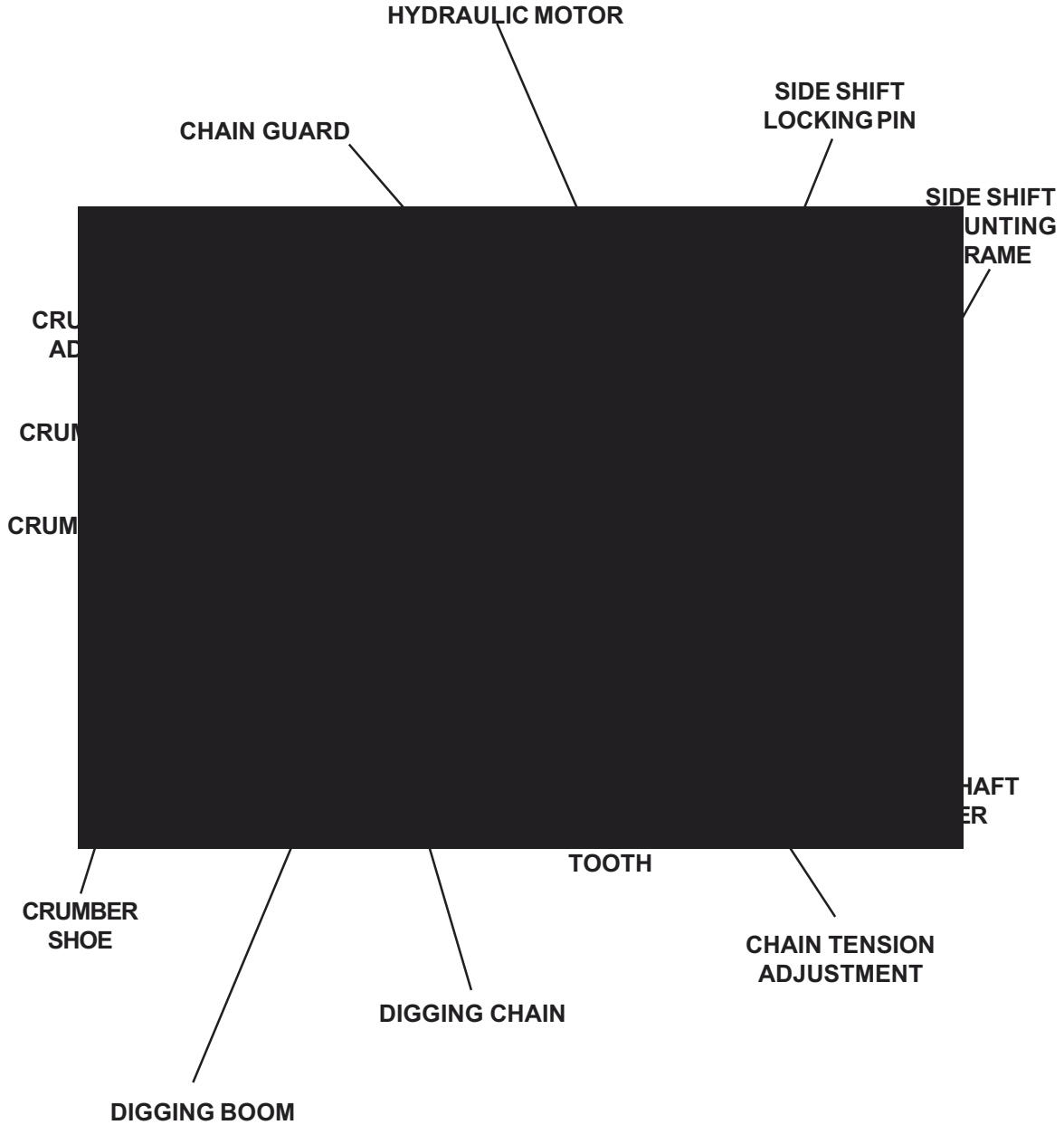

MOUNTING KIT INSTALLATION

HYDRAULIC KITS WITH COUPLERS

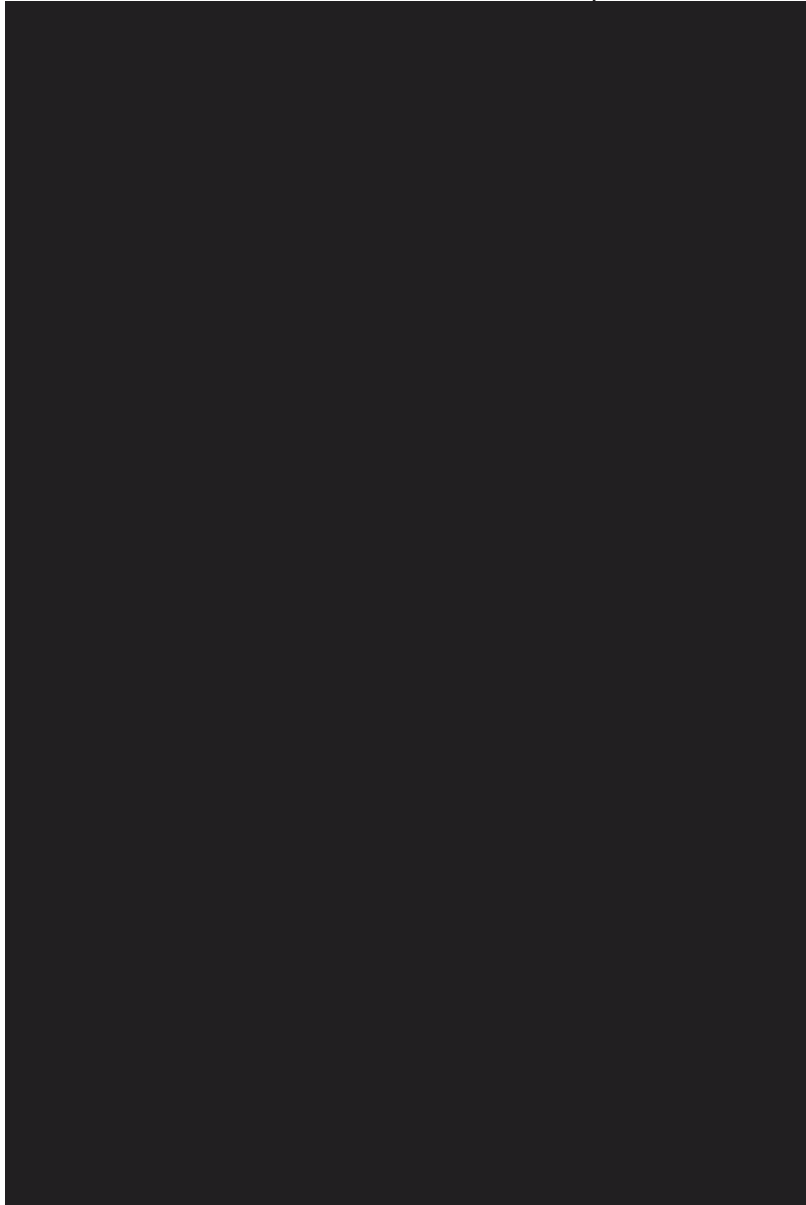

MOUNTING KIT INSTALLATION

HYDRAULIC KITS WITH COUPLERS

HYDRAULIC KIT #89601 (Bobcat, New Holland and John Deere Style Couplers)

<u>NO</u>	<u>REQ'D</u>	<u>PART NO.</u>	<u>DESCRIPTION</u>
1	1	84925	Female Coupler
2	1	84924	Male Coupler
3	2	35792	Hose 82" Long (8MP-10MBo)

HYDRAULIC KIT #89602 (Case Style Couplers)

<u>NO</u>	<u>REQ'D</u>	<u>PART NO.</u>	<u>DESCRIPTION</u>
1	1	86862	Female Coupler
2	1	86863	Male Coupler
3	2	35792	Hose 82" Long (8MP-10MBo)

HYDRAULIC KIT #89603 (Case Style Couplers & Case XT Hoses)

<u>NO</u>	<u>REQ'D</u>	<u>PART NO.</u>	<u>DESCRIPTION</u>
1	1	86862	Female Coupler
2	1	86863	Male Coupler
3	2	37367	Hose 97" Long (8MP-10MBo)

MOUNTING KIT INSTALLATION

HYDRAULIC KITS WITHOUT COUPLERS

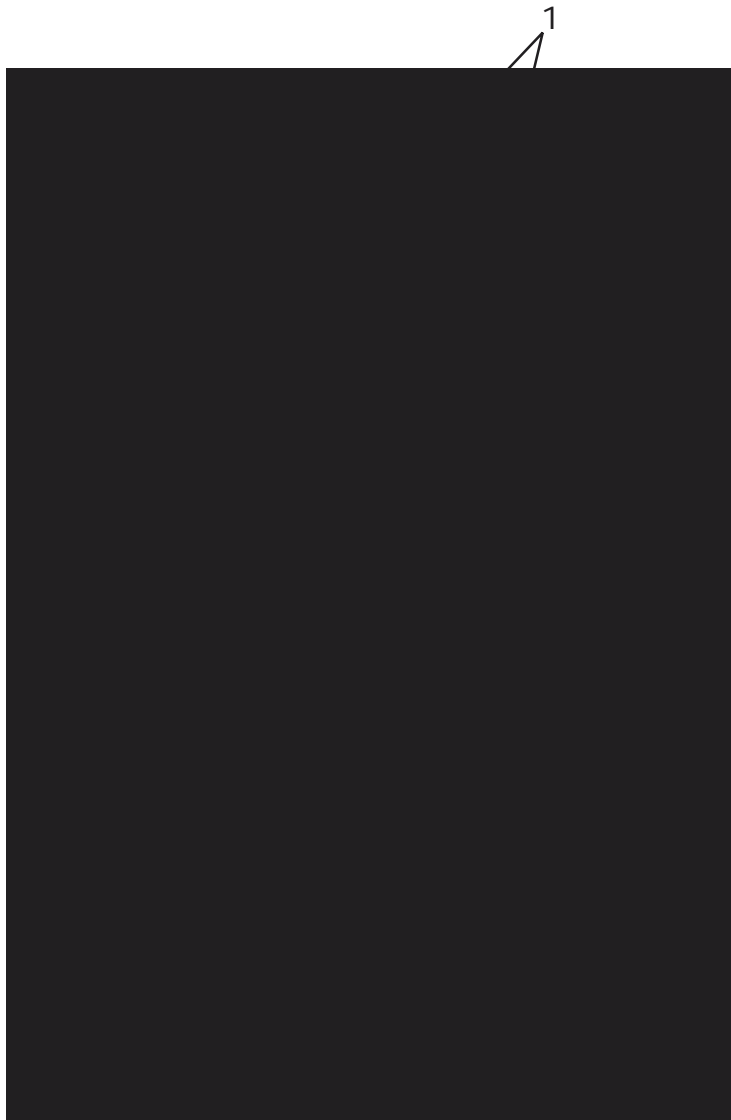

MOUNTING KIT INSTALLATION

HYDRAULIC KITS WITHOUT COUPLERS

HYDRAULIC KIT #89604

<u>NO</u>	<u>REQ'D</u>	<u>PART NO.</u>	<u>DESCRIPTION</u>
1	2	35792	Hose 82" Long (8MP-10MBo)

HYDRAULIC KIT #89605 (Case XT Hoses)

<u>NO</u>	<u>REQ'D</u>	<u>PART NO.</u>	<u>DESCRIPTION</u>
1	2	37367	Hose 97" Long (8MP-10MBo)

MOUNTING KIT INSTALLATION

HYDRAULIC SIDE SHIFT KIT #89412
(WITH SELECTOR VALVE)

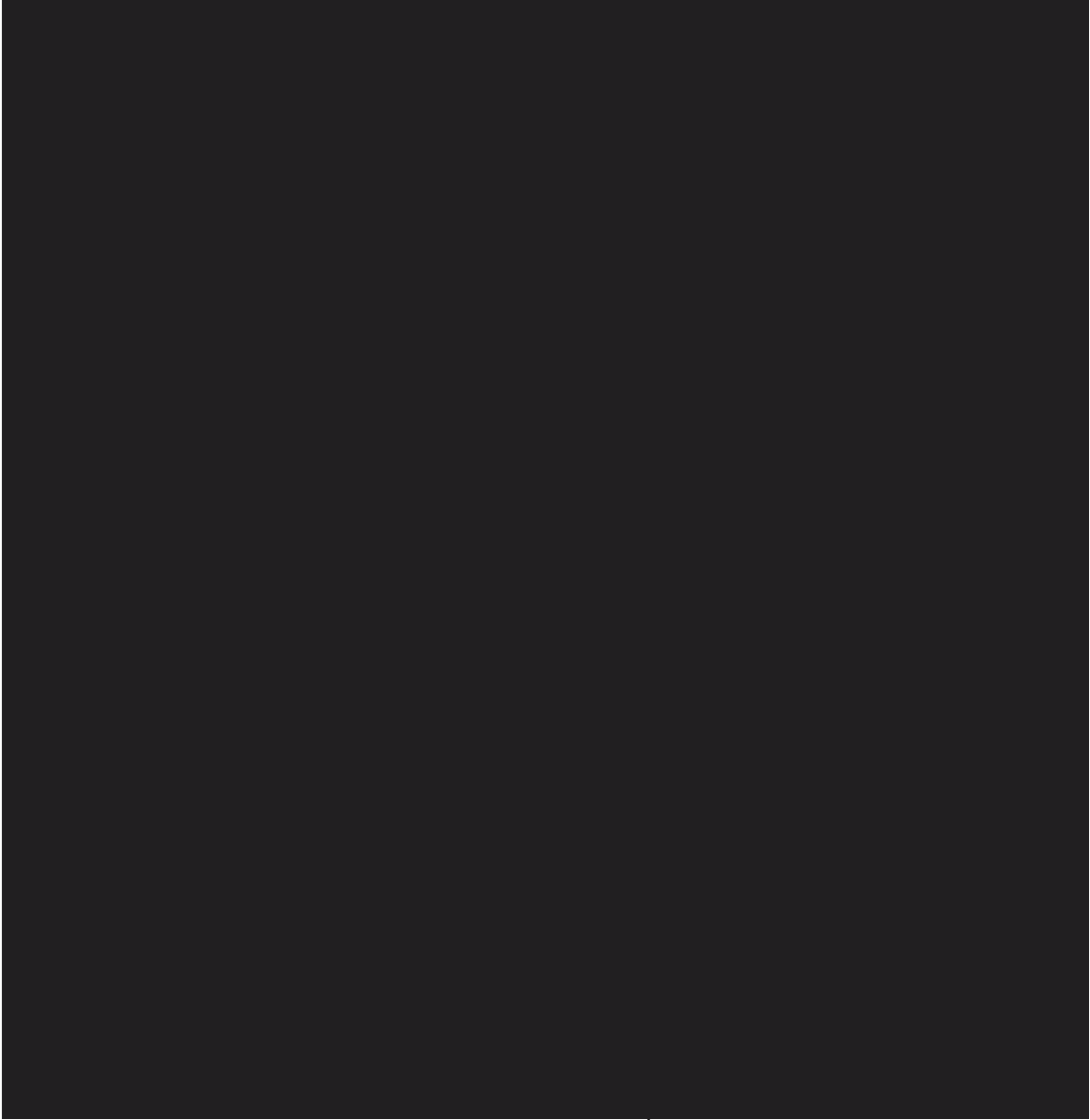

MOUNTING KIT INSTALLATION

HYDRAULIC SIDE SHIFT KIT #89412
(WITH SELECTOR VALVE)

<u>NO</u>	<u>REQ'D</u>	<u>PART NO.</u>	<u>DESCRIPTION</u>
1	2	35950	Hose .25" x 38" (6FJX-6FJX)
2	2	3457	Straight Adapter 6MBo - 6MJ
3	2	22575	Reducer Fitting 12MBo - 6FORFS
4	1	22566	Selector Valve
5	2	30165	90° Elbow 12MBo - 10MJ
6	2	37765	Hose .62" x 8.5" (10FJX-10MBo)
7	4	1225	.31" UNC Hex Nut
8	4	1502	.31" Lock Washer
9	8	1513	.31" Flat Washer
10	2	1030	.31" UNC X 3.00" Hex Capscrew
11	1	89411	Valve Mounting Bracket
12	2	1025	.31" UNC X 1.75" Hex Capscrew
13	2	30198	Straight Adapter 12MBo - 10FBo
14	2	1149	.75" UNC X 5.00" Hex Capscrew
15	1	89101	Cylinder Mount - Mounting Frame
16	2	1171	.88" UNC X 4.50" Hex Capscrew
17	4	1845	.88" Flat Washer
18	2	1739	.88" UNC Nylock Nut
19	1	89110	Side Shift Cylinder Assembly
20	2	1092	.50" UNC X 2.00" Hex Capscrew
21	1	89106	Cylinder Mount - Mainframe
22	1	89148	Angle Mount
23	4	1646	.50" Hard Flat Washer
24	4	1841	.50" UNC Deformed Oval Lock Nut
25	2	1089	.50" UNC X 1.25" Hex Capscrew

MOUNTING KIT INSTALLATION

HYDRAULIC SIDE SHIFT KIT #89279
WITHOUT SELECTOR VALVE
(FOR SECONDARY AUXILIARY HYDRAULICS)



MOUNTING KIT INSTALLATION

HYDRAULIC SIDE SHIFT KIT #89279
WITHOUT SELECTOR VALVE
(FOR SECONDARY AUXILIARY HYDRAULICS)

<u>NO</u>	<u>REQ'D</u>	<u>PART NO.</u>	<u>DESCRIPTION</u>
1	2	1149	.75" UNC X 5.00" Hex Capscrew
2	1	89101	Cylinder Mount - Mounting Frame
3	2	1628	.88" UNC X 4.50" Hex Capscrew
4	4	1845	.88" Flat Washer
5	2	1739	.88" UNC Nylock Nut
6	1	89110	Side Shift Cylinder Assembly
7	2	1092	.50" UNC X 2.00" Hex Capscrew
8	1	89106	Cylinder Mount - Mainframe
9	1	89148	Angle Mount
10	4	1646	.50" Hard Flat Washer
11	4	1841	.50" UNC Deformed Oval Lock Nut
12	2	1089	.50" UNC X 1.25" Hex Capscrew

MOUNTING KIT INSTALLATION

SIDE SHIFT CYLINDER ASSEMBLY #89110



MOUNTING KIT INSTALLATION

SIDE SHIFT CYLINDER ASSEMBLY #89110

<u>NO</u>	<u>REQ'D</u>	<u>PART NO.</u>	<u>DESCRIPTION</u>
1	1	89111	Cylinder Tube
2	1	6992	Piston
3	1	64891	Cylinder Gland
4	1	88464	Cylinder Rod
5	1	1482	Hex Nut
6	1	4637*	O'Ring
7	1	4636*	Piston Ring
8	1	4635*	O'Ring
9	1	52644	Washer
10	1	4633*	O'Ring
11	1	4634*	Back-Up Washer
12	1	45262*	Poly Pak Seal
13	1	7164*	Retaining Ring
14	1	4981*	Rod Wiper

NOTE: Seal Kit #45581 includes all parts marked with an asterisk (*).
Parts are not sold separately.

MOUNTING KIT INSTALLATION

625 TRENCHER HYDRAULIC SIDE SHIFT

GENERAL INFORMATION

The following instructions are provided to help you install the hydraulic side shift kit (with or without a selector valve) in the event that yours was not installed at the factory.

MOUNTING INSTRUCTIONS

1. Remove the existing .75" x 4.50" capscrews from the left side of the side shift mounting frame on the trencher. See Figure #1.
2. Slide the cylinder mount #89101 into position and install the .75" x 5.00" capscrews. Secure in place with the existing lock nut removed in step #1. See Figure #1.

FIGURE

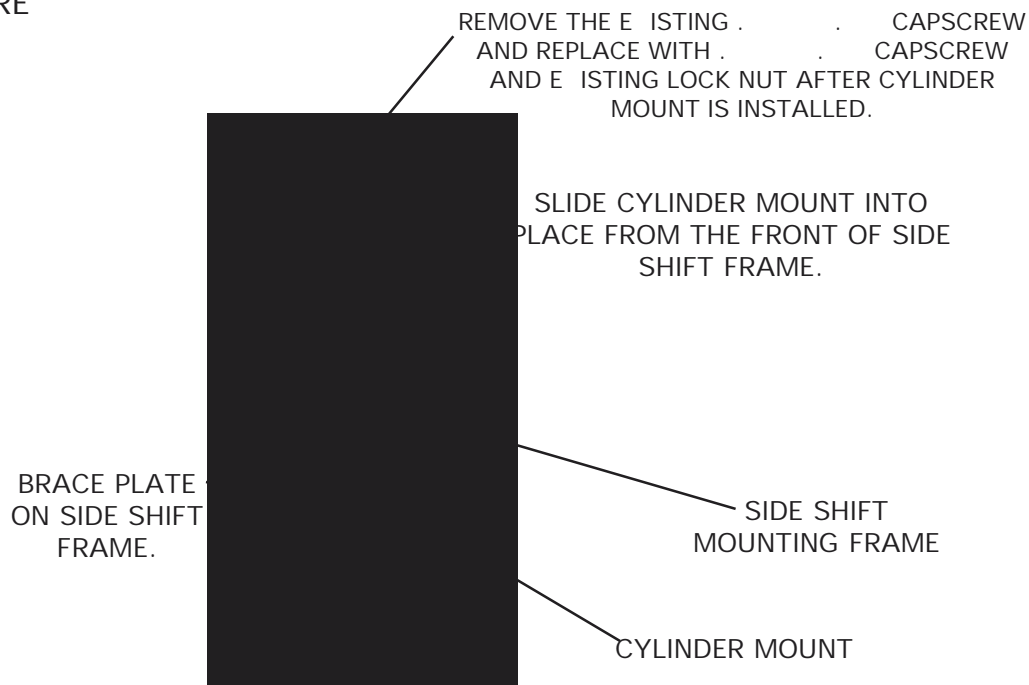

3. Place the remaining cylinder mount on the inside of the .75" plate on the back of the trencher as shown in Figure #2 with the angle mount on the outside of the plate. Align the holes and install the .50" x 2.00" capscrews through the cylinder mount, the trencher and the angle mount while using the .50" x 1.25" capscrews through the cylinder mount and the angle mount. Install the flat washers and lock nuts provided. See Figure #2.

MOUNTING KIT INSTALLATION

625 TRENCHER HYDRAULIC SIDE SHIFT

FIGURE #2

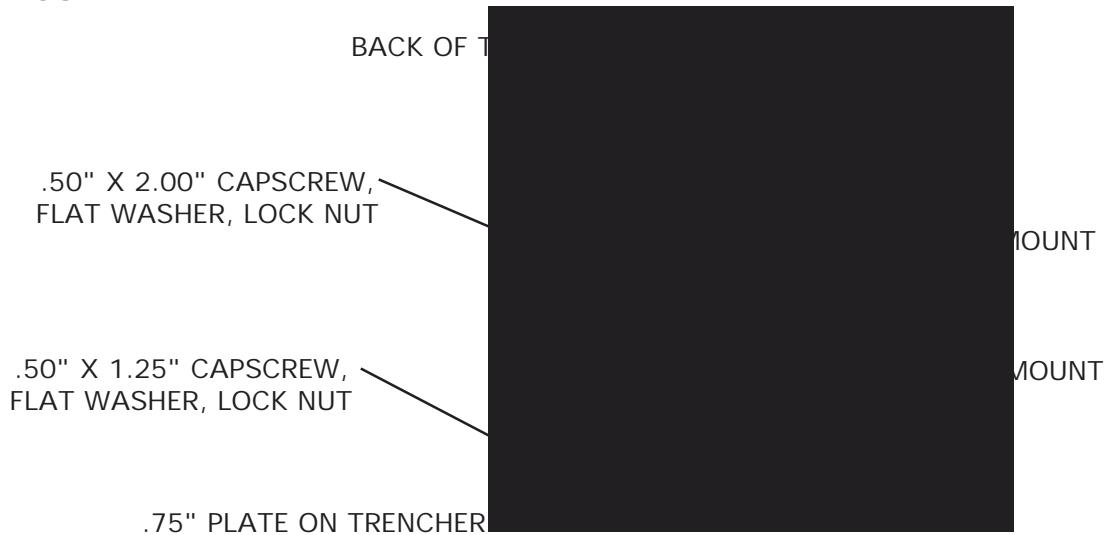

89110
88 0

FIGURE #3

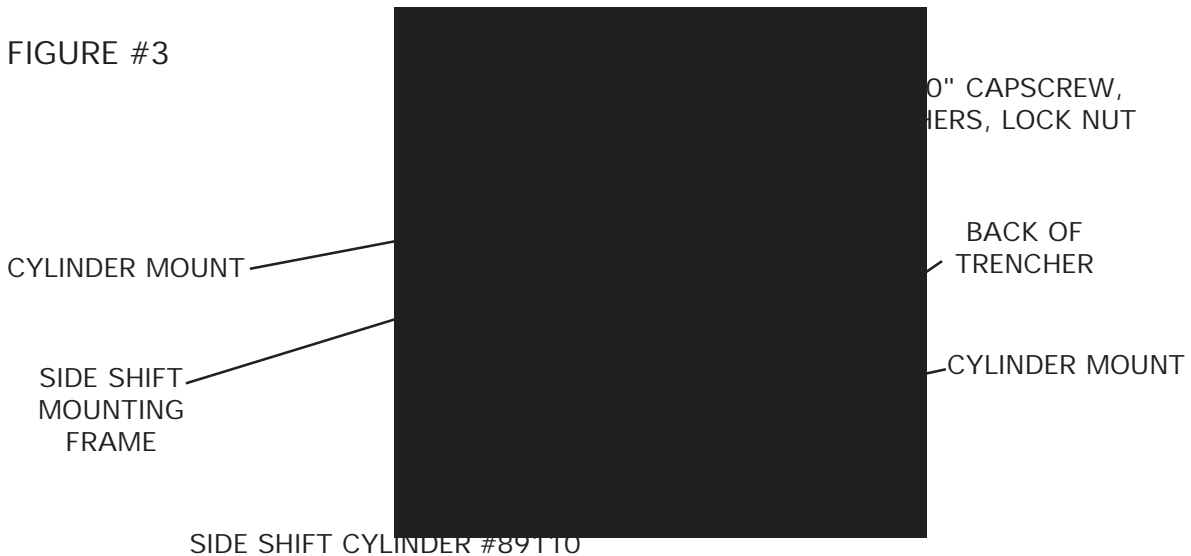

892 9

89 12

NOTE: Due to the different locations of the secondary hydraulics on the various skid-steer loaders, hoses are not included in this kit. To determine the hose lengths for your skid-steer, measure the distance from the secondary hydraulic couplers to the side shift cylinder ports when the loader is fully raised and tilted down. The hose connection at the cylinder is #6FJX and the hose size should be .25" diameter with 3000 PSI working pressure (Route hoses in such a fashion to prevent pinching and chafing.)

8 0
2- -01

MOUNTING KIT INSTALLATION

625 TRENCHER HYDRAULIC SIDE SHIFT

90

01

22

0198

1 00

SELECTOR VALVE

FIGURE

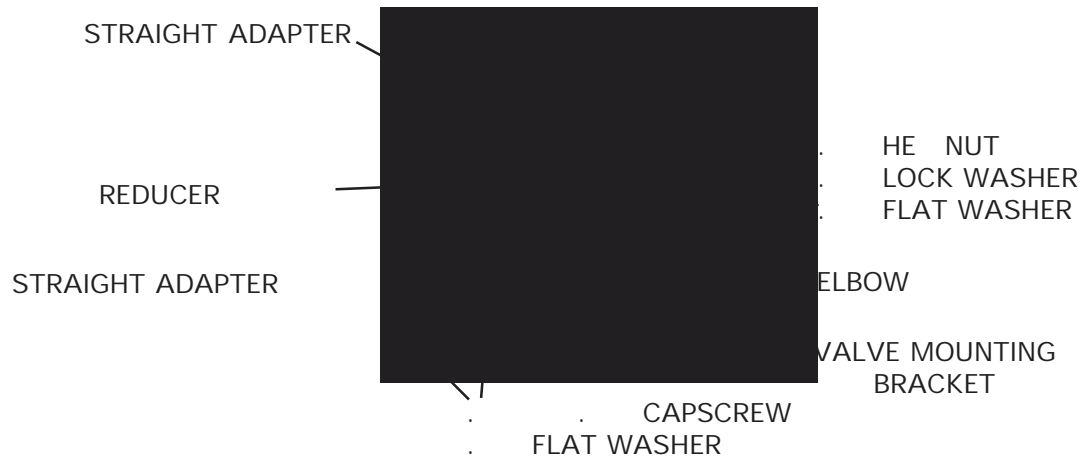

8

8 0

FIGURE

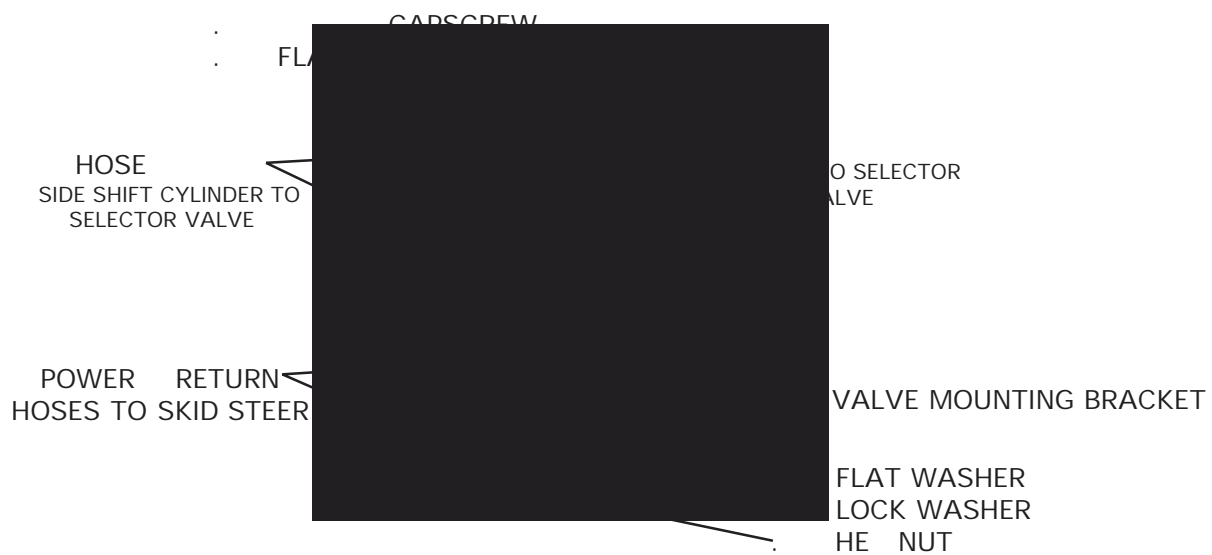

8331
2- -01

MOUNTING KIT INSTALLATION

625 TRENCHER HYDRAULIC SIDE SHIFT

9. Connect the 8.50" hoses to the 90° elbows on the selector valve.
See Figure #5
10. Loosely bolt the valve mounting bracket to the trencher using the two .31" x 1.75" capscrews, flat washers, lock washers and hex nuts provided. See Figure #5

NOTE: All trenchers are currently being manufactured with mounting holes for the valve mounting bracket. If your trencher does not have the mounting holes predrilled refer to Figure #6 for location and drill two .38" holes.

FIGURE #6



11. Connect the two 38" hoses #35950 to the side shift cylinder ports, route hoses through the side shift mounting frame and into the straight adapter fittings in the left side of the selector valve. See Figure #5
12. Tighten all capscrews.

TRENCHER INSTALLATION

625 TRENCHER

GENERAL INFORMATION

- - -
-

MOUNTING INSTRUCTIONS

1

2

- - -
- - -

-
-

-

OPERATING INSTRUCTIONS

CONTROLS 625 TRENCHER

GENERAL INFORMATION

Simplicity of operation is one of the key features of the 625 trencher. The trenchers themselves have no controls, just a few adjustments to check. It is important however, to be familiar with, and know the controls and adjustments on both the trencher and the skid steer. Such knowledge is crucial for safe, efficient operation of equipment. Take the time to learn how they operate now.

SKIDSTEER

Your trencher mounts to the toolbar / attachment plate of the skid steer. Due to this arrangement, thorough knowledge of the skid steer controls is necessary for trencher operation. Read your skid steer owner's manual for information regarding skid steer operation before attempting to use the trencher.

RAISING / LOWERING THE TRENCHER

Raise / lower the trencher unit by raising / lowering the skid steer loader arms through their appropriate skid steer controls. (See Figure #1)

CAUTION! Become aware of any overhead power or telephone lines, tree limbs, etc., that the raised trencher could come into contact with. Contact with electrical lines could cause serious injury or death.



OPERATING INSTRUCTIONS

CONTROLS 625 TRENCHER

TILTING THE TRENCHER

Tilt the trencher unit up or down by tilting the toolbar / attachment plate back or forward through its skid steer control. We recommend a 60° digging angle for general trenching as measured from ground level (the horizon). (See Figure #2)

F

S

Your trencher has an adjustment to shift the whole unit to the side on its own mount. To shift the unit sideways, first remove the locking pin from the back of the unit.

Lower trencher until trencher frame is resting on the ground, then counter-rotate the tires so that the skid steer moves in a sideways motion. Continue moving until side shift holes are aligned and replace locking pin.

IMPORTANT: Always reinstall the locking pin to prevent the trencher from shifting sideways during operation.

NOTE: Slight shifting of the trencher from side to side may be necessary to align the side shift holes for reinstalling the locking pin.

OPERATING INSTRUCTIONS

CONTROLS 625 TRENCHER

STARTING AND STOPPING THE TRENCHER

Power to the trencher is supplied by oil from the skid steer auxiliary hydraulic system, which passes through the hydraulic hoses and into the trencher's hydraulic motor.

The trencher unit itself does not have an on/off control but is operated by the skid steer auxiliary hydraulic control mechanism. To start the trencher, engage the auxiliary hydraulics. (This is usually done by a pedal located in the middle of the skid steer floor. See your skid steer owner's manual.) To stop the trencher, disengage the auxiliary hydraulics.

TRENCHER SPEED CONTROL

Again it may be noted that power to the trencher is supplied by the skid steer's auxiliary hydraulics. Trencher speed and power are determined by the flow of oil coming out of the auxiliary system, which in turn is dependent upon skid steer engine speed. To increase trencher speed, increase skid steer engine speed, to decrease trencher speed, decrease skid steer engine speed.

When first starting a trench throttle down the skid steer engine to half throttle. This will reduce the shock to the skid steer and trencher when the digging teeth first contact the ground. Once the trench is started, set the engine back to full throttle.

For general use operate the trencher with the skid steer engine at full throttle to provide maximum power to the auxiliary hydraulics and thus the trencher.

AUGER HEIGHT

The auger is fixed to the trencher mainframe and has no separate adjustment. To raise the auger, raise the trencher as previously described. This will raise the auger and thus leave the dirt or spoil closer to the trench.

Lowering the trencher will cause the auger to lower, moving the spoil away from the trench. The built-in skid shoe on the 625 trencher will prevent the auger from being lowered to the extent that the auger itself starts to dig in the ground as this will greatly reduce efficiency.

OPERATING INSTRUCTIONS

**CONTROLS
625 TRENCHER**

It should be noted that raising or lowering the trencher to change the auger height will also change the trenching depth. You will need to compensate for this by changing the tilt of the trencher down or up accordingly. (See Figure #3)

FIGURE #3**CRUMBER SHOE/BAR ADJUSTMENT**

The purpose of the crumber shoe is to keep any loose dirt in the trench close enough to the digging chain so that the digging teeth can grab it and remove it. This will give you a cleaner finished trench. Your trencher has an adjustable crumber bar that can be lengthened or shortened to bring the crumber shoe closer or farther from the digging chain.

To adjust the crumber bar length, loosen the two jam nuts found at the end of the mainframe crumber bar tube. Slide the bar in or out to achieve the desired spacing (we suggest a distance of about 4" between crumber shoe and digging teeth for best overall results). Tighten the set screws and jam nuts when finished. (See Figure #4 on the next page)

OPERATING INSTRUCTIONS

CONTROLS 625 TRENCHER

FIGURE #4



When trenching, the digging chain tension should be adjusted so that the chain is as loose as possible, without jumping off the sprocket or idler wheel. To do this, an adjustment is provided on the digging boom.

These booms have an adjusting bolt on each side at the trencher end of the boom. The head of the bolts are kept from rotating by special tubes welded onto the mainframe. The end of the bolt rests in a tube welded to the boom. Each bolt has a jam nut and a .75" hex nut on it. To tighten the chain, "back off" the jam nut from the regular nuts. Now turn the standard nuts off the adjusting bolts. This will push the boom out and thus tighten the chain. Retighten the jam nut when finished. To loosen the chain, follow the same procedure, except turn the hex nut onto the adjusting bolt. (See Figure #5)

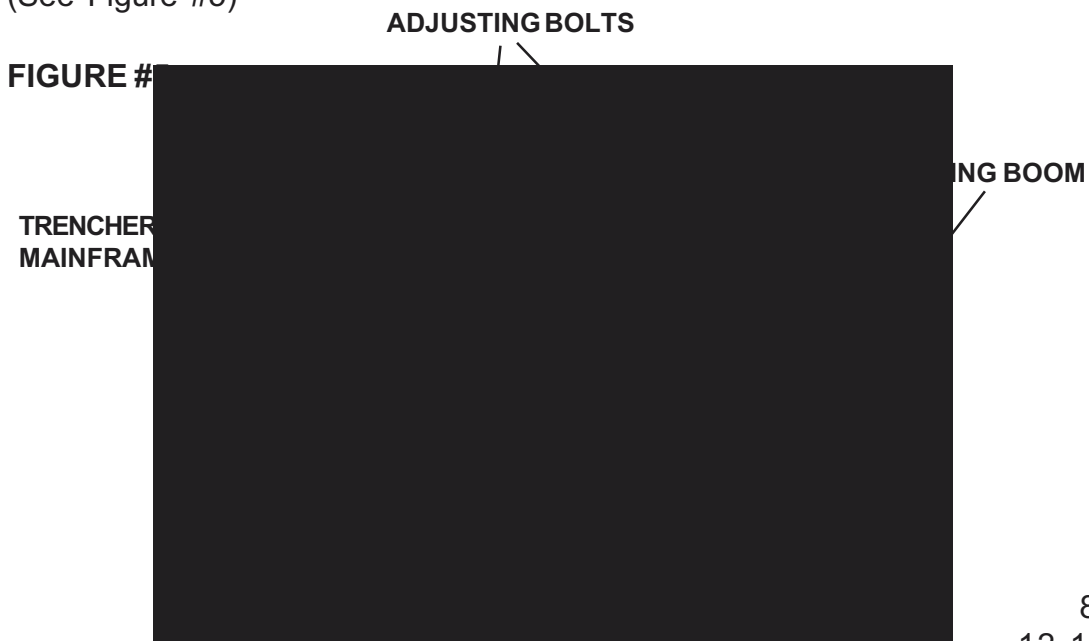

OPERATING INSTRUCTIONS

CONTROLS 625 TRENCHER

This procedure must be done simultaneously to both adjusting bolts to prevent the boom from becoming wedged onto its mount.

CAUTION! Never work on, or make adjustments to any part of the trencher while the unit is running. You could get caught in the digging teeth which could cause severe injury or death.



It is common for your trencher to need its digging chain tightened after the first 10 to 20 minutes of operation as the chain and sprocket seat themselves.

OPERATING INSTRUCTIONS

OPERATING TECHNIQUES SKID STEER TRENCHERS

GENERAL INFORMATION

The design of your trencher makes it relatively simple to use. With the help of the information in this section and a little practice you should become proficient in its operation in no time. Observe the following points to obtain the best results with the least amount of wear on the machine. Read the "Safety Precautions" section of this manual before you begin. (See Section B)

CAUTION! Operate the trencher only when seated at the skid steer controls.



Do not operate the skid steer without proper ROPS (Roll-Over-Protective-Structure), seat belt, and hard hat.

Pay attention to the job at hand. Be alert to the possibilities of others in the work area.

Never let anyone work around, or perform maintenance on the trencher while it is running.

Always use a crumber assembly on the trencher.

BEFORE YOU START TRENCHING

Before any excavating is started, it is always a good idea to plan out the job first. Various things need to be considered and taken into account prior to the actual trenching. The operator should inspect the job site and take notice on any potential hazards in the area. He should have a complete understanding of the task he is expected to perform. Figure out what will be done with the spoil (excavated soil), will it be used to backfill or be trucked out? What are the soil conditions like? Will you have to work around others? Etc.

WARNING! Check the prospective trenching area for hidden utility lines before operating the trencher. Contacting a utility line with the trencher could cause electrocution resulting in death. Call all utility companies and have them plot out all their lines first. If you damage a utility line, shut off the equipment at once and contact the affected utility immediately.



Once you have become familiar with the job site and understand the job requirements it is time to set up for the actual trenching. Check the soil type (hard, soft, rocky, etc.) and the trenching requirements (how deep, wide, etc.). Install the proper digging chain, sprocket, boom, crumber bar and shoe for the job at hand. Information on chains, sprockets, booms, crumber bars and shoes may be found in Sections I and J.

OPERATING INSTRUCTIONS

OPERATING TECHNIQUES SKID STEER TRENCHERS

Locate the trencher on the mount with the side shift mechanism (as explained earlier in this section) where it will be most efficient and easy to use.

Mark off the area to be trenched out. This can be done with powdered lime, chalk, or a guide string and stakes. Block off the area from all bystanders if possible.

STARTING THE TRENCH

Position the skid steer with the trencher boom directly over the center of the trench layout. It will take about 4' of trenching before the trencher will be able to operate at the desired level, so plan for this and position the trencher about 4' behind where you want the actual trench to start.

NOTE: The skid steer is driven in reverse when trenching. You cannot trench driving the skid steer forward.

Raise the trencher with the skid steer loader arms and tilt the trencher at a 45° angle. (See Figure #6) Position the unit so that the digging teeth are just above ground level.

Set the skid steer throttle at half speed. Start the digging chain by engaging the skid steer auxiliary hydraulic system.

FIGURE #6

TOOLBAR

LOADER ARM



OPERATING INSTRUCTIONS

OPERATING TECHNIQUES SKID STEER TRENCHERS

CAUTION! When lowering a moving digging chain to the ground the force of the teeth grabbing the ground will try to pull the trencher suddenly forward. Be prepared. Have the brake on the skid steer set to help counteract the force.

Slowly lower the digging chain into the ground to start the trench. Do this by lowering the trencher with the loader arms. Continue lowering the unit until the crumber end rolls all the way back on the crumber bar (See Figure #7)

IMPORTANT: After the crumber end has rolled all the way back, do not lower the trencher any farther without moving the skid steer in reverse. Failure to do so could result in bending of the crumber boom, which is not covered by warranty.

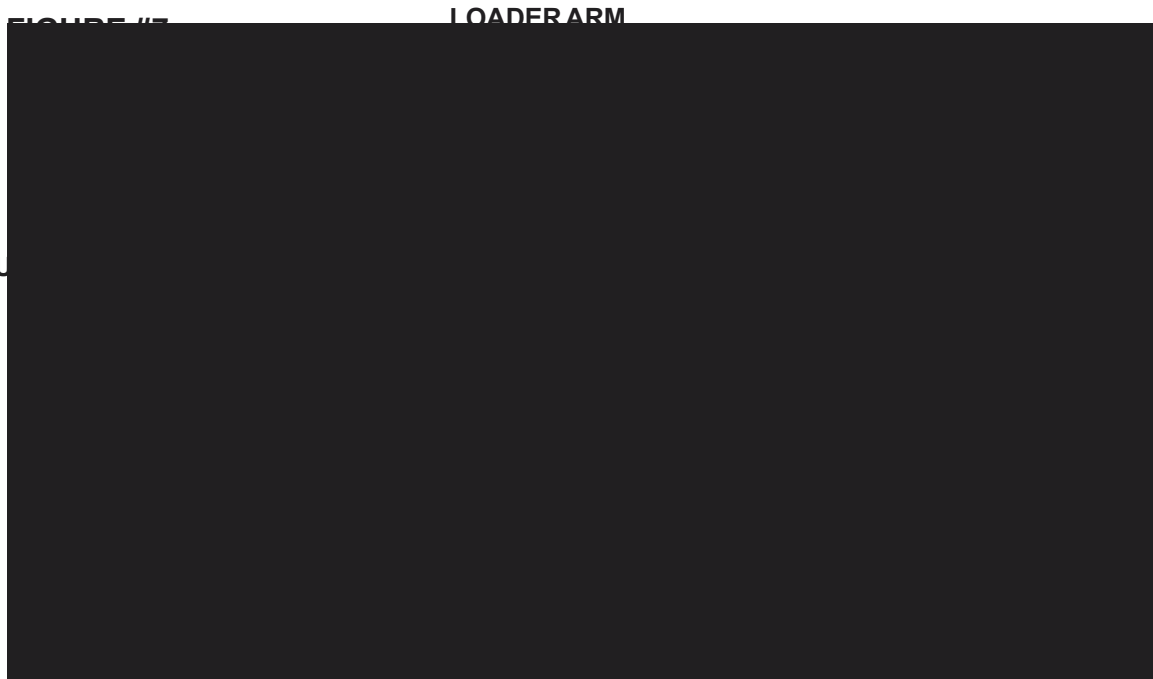

Once the crumber end has "bottomed out", begin slowly creeping the skid steer in reverse while continuing to lower the loader arms. When nearing the required depth, stop lowering and tilt the trencher to a 60° to 65° angle. A 60° - 65° angle works best for general trenching. (See Figure #8)

WARNING! Be alert to what is happening around you. Look behind you before reversing the skid steer to trench. Be aware of any person or thing in the path of the skid steer. Observe any terrain changes such as drop-offs or soft ground.

OPERATING INSTRUCTIONS

OPERATING TECHNIQUES SKID STEER TRENCHERS

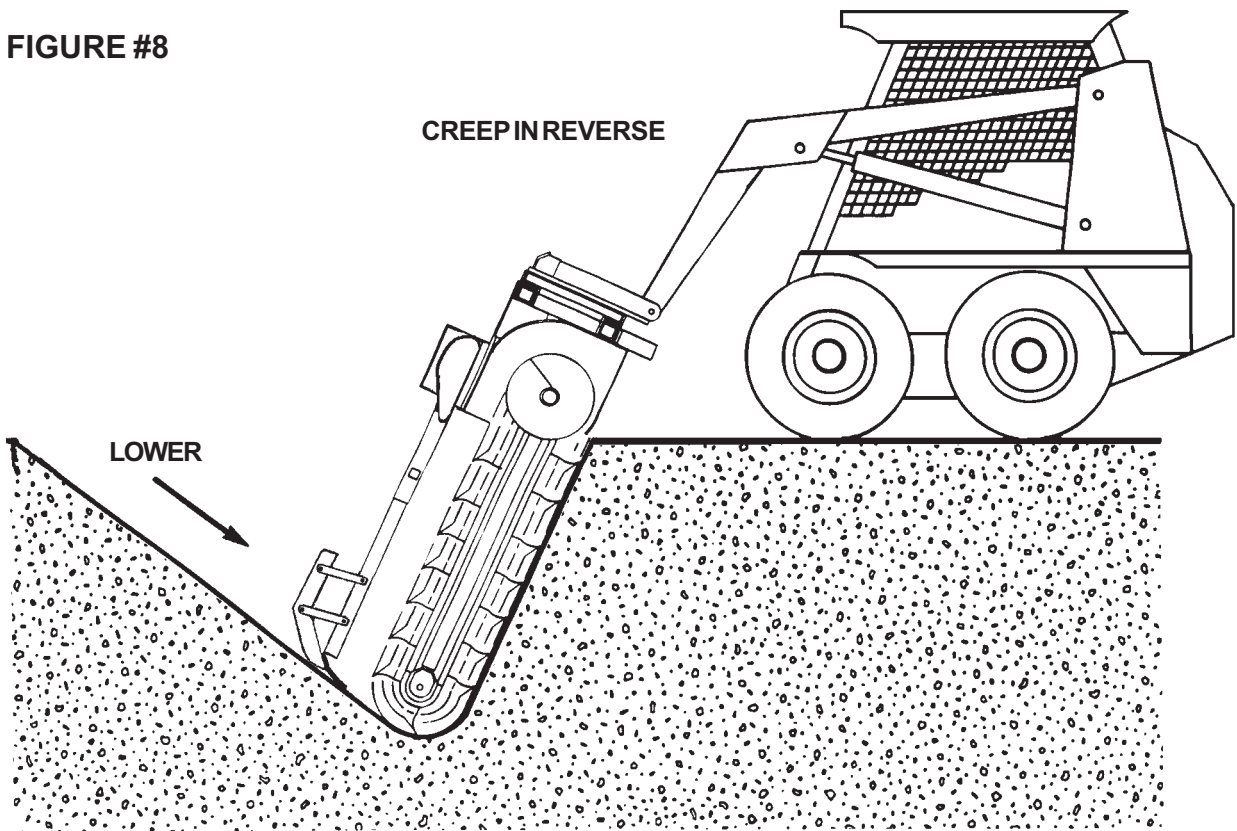
FIGURE #8

When trenching, remember to keep in mind the spoil placement. Position the trencher so that the auger floats at ground level to move spoil away from the trench. (See Figure #9)

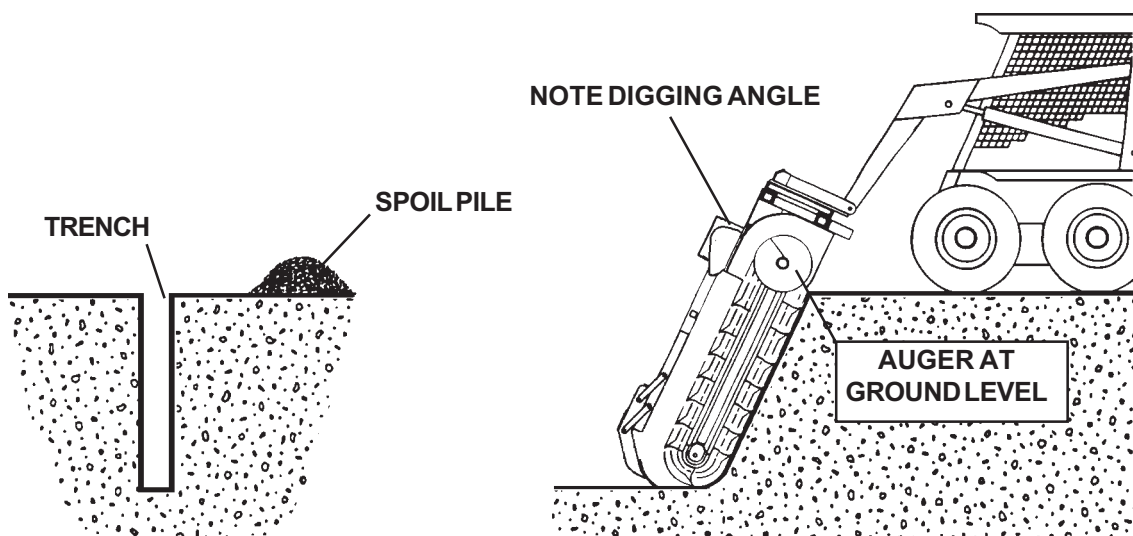
FIGURE #9

OPERATING INSTRUCTIONS

OPERATING TECHNIQUES SKID STEER TRENCHERS

Raise the trencher so that the auger rides above the ground level to leave the spoil beside the trench. The higher the auger, the closer to the trench the spoil will be placed. You may find that it generally takes less power to run the digging chain if the auger runs 3" - 6" (inches) off the ground, and thus increasing the potential footage of trench produced per hour. The higher you want the auger, the more vertical you will have to tilt the trencher to achieve the same trench depth. (See Figure #10)

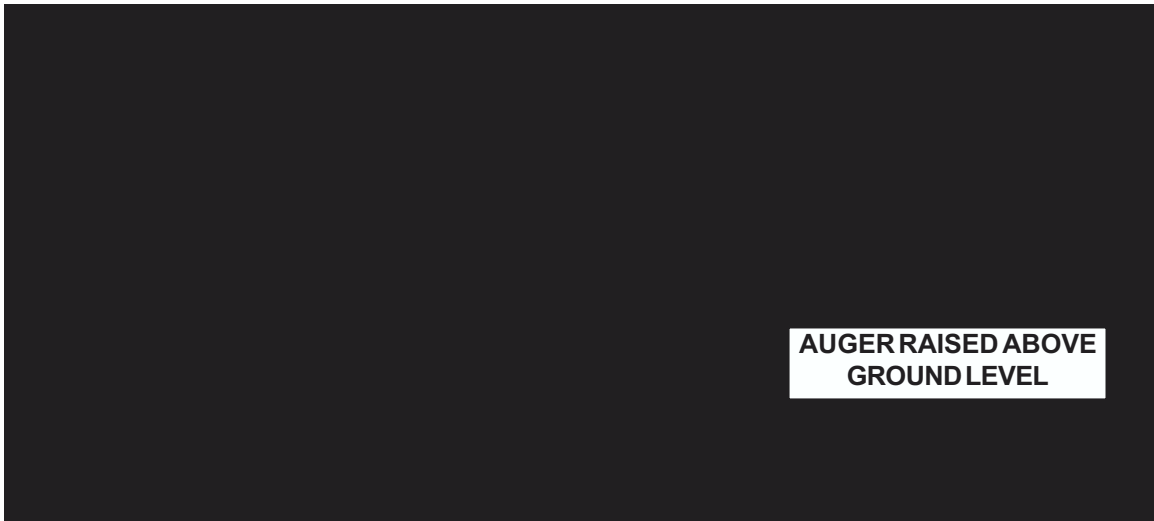

With the desired trench depth reached, advance the skid steer throttle to the desired engine RPM (we suggest full throttle for maximum digging power). Continue creeping the skid steer in reverse. Monitor the skid steer hydraulic oil pressure and temperature gauges as you trench. If hydraulic oil temperature or pressure gets too high, reduce skid steer creeping speed to reduce the load on the auxiliary hydraulic system.

IMPORTANT: Trying to trench at a speed faster than the auxiliary hydraulic system can handle could cause the trencher to stall. Continued stalling in a short period of time can cause excessive oil temperature which can lead to pump failure. Do not try to trench too much too quickly. If oil temperature becomes too hot, stop the trencher and allow the oil to cool.

STALLING THE TRENCHER

If the trencher stalls while digging, move the skid steer forward slightly to free the trencher. You may be able to free up the digging chain by changing its direction of travel with the auxiliary hydraulic controls. Repeated stalling of the trencher will cause oil to overheat rapidly and should be avoided.

OPERATING INSTRUCTIONS

OPERATING TECHNIQUES SKIDSTEER TRENCHERS

TURNING WHILE TRENCHING

Gradual turns can be made while trenching. However, the tightness of the turn is directly proportional to the angle and length of the boom. In other words the greater the angle of the trencher boom to the ground level, the sharper the turn that can be trenched. (See Figures #11 & #12) Also the shorter the boom length the sharper the possible turn. Remember, the greater the increase in boom angle the higher the unit will have to be raised out of the trench to keep a unified trench depth. Shallow boom angles will severely limit turning ability.

IMPORTANT: Turning too tightly while trenching will cause the trencher to jam in the trench and stall, leading to excessive oil temperatures. Turning too tightly can also cause the trencher boom to bend. Take it easy when turning. Proceed slowly with caution.

F



OPERATING INSTRUCTIONS

OPERATING TECHNIQUES SKIDSTEER TRENCHERS

MAKING SHARP TURNS

To make sharp turns and 90° angles you will have to dig two trenches. Dig the first trench as you normally would. Then reposition the unit and dig the second trench at the appropriate angle. Be sure to take into account the extra lead-in space needed for the trencher to get down to the desired trench depth. (See Figure #13)

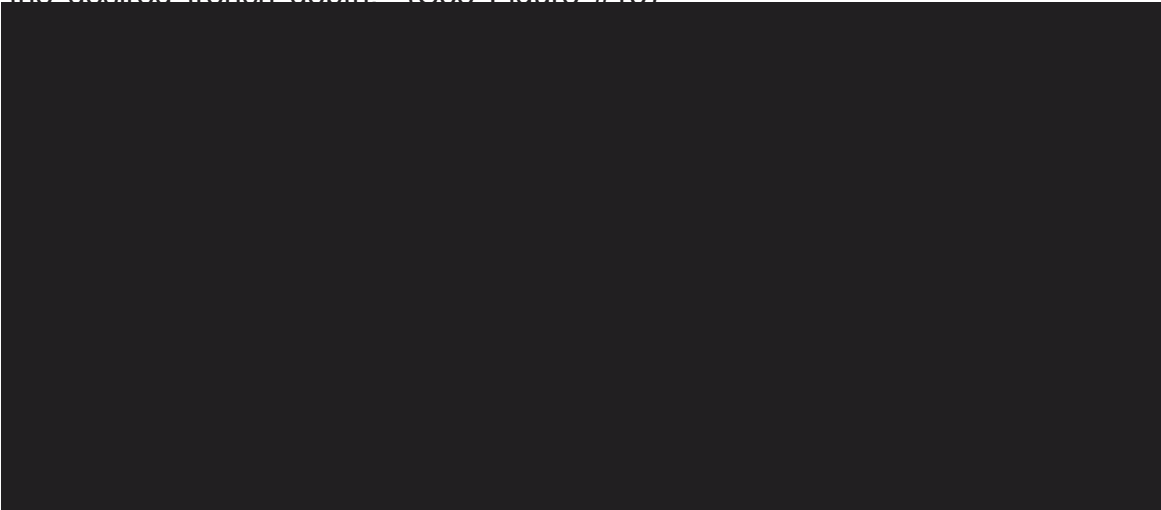

RECOMMENDED DIGGING ANGLES

A 90° digging angle is recommended for use in rock and frost conditions, and when trenching sharp corners. The 90° angle reduces excessive side pressure on the boom and digging chain when trenching corners. (See Figure #14)

A 60° - 65° digging angle is recommended for normal trenching. At this angle there will be less carry-over, and a cleaner trench bottom can be maintained than at a 90° angle. (See Figure #14)

FIGURE #14



OPERATING INSTRUCTIONS

OPERATING TECHNIQUES SKID STEER TRENCHERS

TRENCHING WITHOUT THE CRUMBER ASSEMBLY

WARNING! The crumber bar and crumber shoe assembly are there for a reason, YOUR SAFETY! There are a few instances where removal may be necessary however. In these cases operate with extreme caution. Reinstall the crumber bar and crumber shoe as soon as possible.



You can use your trencher to dig under obstacles such as sidewalks. To do so, remove the crumber shoe and bar assembly and start your trench as before within a foot of the sidewalk. With the crumber bar and shoe removed you can start the trench vertically without any lead-in space.

When the desired depth has been reached, tilt the trencher at a 60° angle while digging, then creep the skid steer forward and trench under the sidewalk. Be careful not to contact the edge of the sidewalk with the digging teeth.

After you have gone as far as you can without contacting the sidewalk, drive the skid steer in reverse to clear the sidewalk and remove the trencher from the trench. Line up the unit on the other side of the walk and continue to trench as described above until the two trenches are connected. (See Figure #15)

FIGURE #15

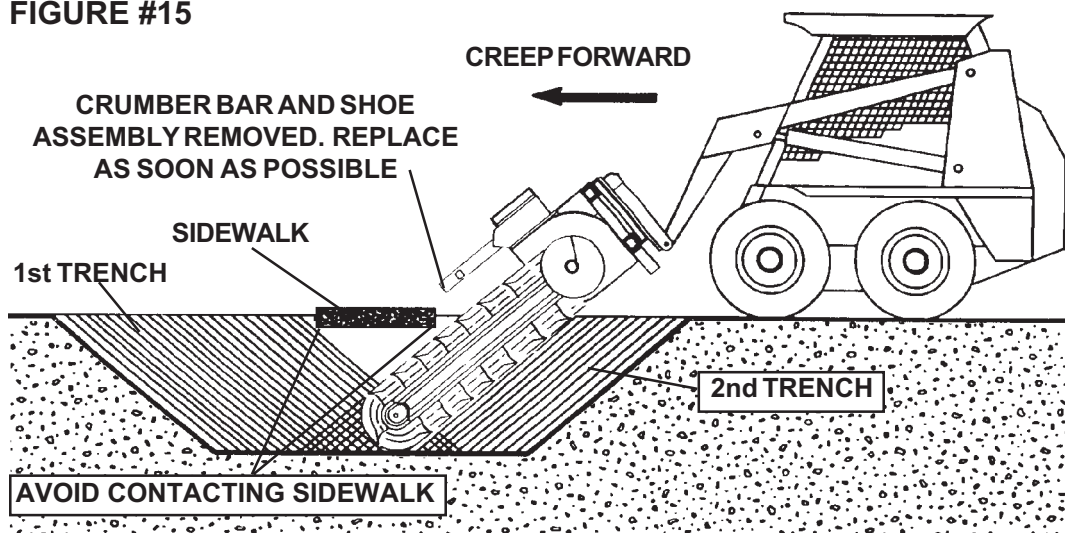

Reinstall the crumber bar and crumber shoe assembly immediately. Some spoil will be left in the trench since the crumber was removed during the operation.

OPERATING INSTRUCTIONS

OPERATING TECHNIQUES SKID STEER TRENCHERS

ENDING A TRENCH

When you have dug your trench, remember that the trencher boom is at an angle, and that you must continue trenching until the end of the boom has dug past the proposed end of the trench. Once the end of the trench has been dug, keep the trencher running and lift the skid steer loader arms to lift the unit clear of the trench. When the trencher has cleared the trench, disengage the auxiliary hydraulics to stop the trencher. Drive the skid steer away from the trench.

TRANSPORTING THE TRENCHER

When transporting the trencher, remember to keep the trencher as low to the ground as is practical. The lower the trencher rides, the more stable the skid steer will be. You do not want the trencher so low that the digging teeth touch the ground in rough terrain. Shut off the trencher before moving it away from the trench. Never transport the trencher around the job site or anywhere else while the digging chain is moving.

TRENCHER PERFORMANCE

Remember that your trencher's performance is directly related to the power available at your skid steer's auxiliary hydraulic system. If the trencher seems to lack power or speed, it may be due to your skid steer's lack of sufficient auxiliary power.

Trencher performance is also related to how well it's maintained, digging tooth wear, and type and size of digging chain, crumber boom and shoe used. For more information on proper maintenance and chain wear see Section L. For information on chain, sprocket, boom, and crumber options see Sections I and J. If problems arise see "Trouble Shooting" Section N.

I

TRENCHER ASSEMBLY

I

625 TRENCHER
ASSEMBLY #89290

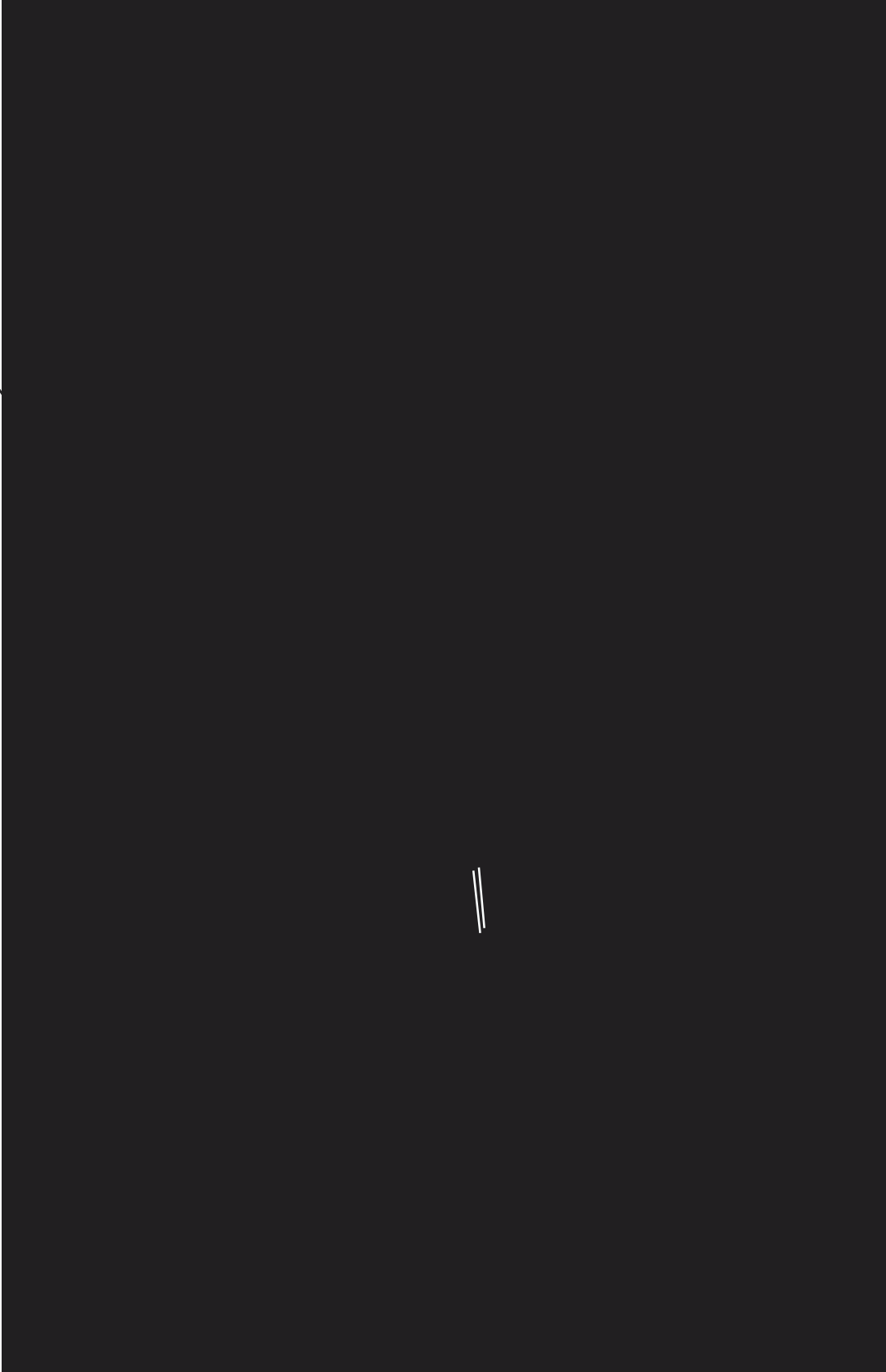

10

4

8278
11-1-00

TRENCHER ASSEMBLY

625 TRENCHER ASSEMBLY #89290

<u>NO</u>	<u>REQ'D</u>	<u>PART NO.</u>	<u>DESCRIPTION</u>
1	1	79113	Lock Pin
2	1	88550	Side Shift Mounting Frame
3	4	1148	.75" UNC x 4.50" Hex Capscrew
4	4	1534	.75" UNC Lock Nut
5	2	78824	Side Shift Inner Tube
6	9	1021	.31" UNC x .75" Hex Capscrew
7	9	1502	.31" Lock Washer
8	9	1513	.31" Flat Washer
9	1	89099	Top Cover Plate
10	1	89098	Chain Guard
	7	1989	.31" UNC Cage Nut
11	1	1364	.62" UNF x 1.50" Hex Capscrew
12	1	1506	.62" Lock Washer
13	1	1517	.62" Flat Washer
14	1	78823	Sleeve Spacer
15	1	78821	Driver Sprocket
16	1	67799	Key (.312" x .275" x 1.25")
17	4	1091	.50" UNC x 1.75" Hex Capscrew
	2	1092	.50" UNC x 2.00" Hex Capscrew
18	2	78844	Adjusting Bolt
19	1	78838	Motor Mounting Plate
20	1	89287	Hydraulic Motor
21	8	1505	.50" Lock Washer
22	8	1228	.50" UNC Hex Nut
23	4	1516	.50" Flat Washer
24	1	89089	Mainframe
25	1	78837	Drive Chain (#80 - 52 Pitches)
26	1	53298	Connecting Link
27	2	1769	.50"UNC x 1.00" Sq. Head Setscrew
28	2	1242	.50" UNC Jam Nut
29	1	1651	Snap Ring
30	Varies	6622	Thrust Washer
31	1	78822	Driven Sprocket
32	5	1572	.50"-13UNC x .50" Set Screw
33	1	53744	Key (.50" x .50" x 2.00")
34	1	78809	Headshaft Spacer
35	1	1681	Snap Ring
36	1	78841	Bearing
37	1	6616	Grease Zerk
38	1	8085	Bearing
39	1	1601	Snap Ring
40	1	78833	Dirt Guard
41	1	78808	Headshaft
42	1	53742	Key (.38" x .38" x 3.00")
43	1	86191	Sprocket
44	2	1095	.50" UNC x 2.75" Hex Capscrew
45	1	78828	Auger

TRENCHER ASSEMBLY

30" BOOM AND CRUMBER
ASSEMBLY #89281



TRENCHER ASSEMBLY

30" BOOM AND CRUMBER
ASSEMBLY #89281

<u>NO</u>	<u>REQ'D</u>	<u>PART NO.</u>	<u>DESCRIPTION</u>
1	4	1101	.50" UNC x 4.50" Hex Capscrew
2	16	1646	.50" Hard Flat Washer
3	4	1841	.50" UNC Lock Nut
4	4	21061	Lever Arm
5	4	1514	.38" Flat Washer
6	1	89278	Crumber End
7	2	1226	.38" UNC Hex Nut
8	2	1503	.38" Lock Washer
9	2	1044	.38" UNC x 1.25" Hex Capscrew
10	2	54067*	Idler Spacer
11	1	79103*	Idler Wheel
12	1	8085*	Idler Bearing
13	1	53988*	Idler Bearing Hub
14	2	40161	Decal - Stand Clear
15	1	89276	30" Crumber Bar / Personal Restraint Bar
16	1	53138	Boom Bushing
17	1	80087	30" Boom
18	1	53132	1.12" Square Pin
19	1	1548	.75" UNC x 1.25" Nylock Capscrew
20	2	62702	Adjusting Bolt
21	2	1245	.75" UNC Jam Nut
22	2	1231	.75" UNC Nut

NOTE: Idler Roller Assembly Repair Kit #80868 includes all parts marked with an asterisk (*).

TRENCHER ASSEMBLY

36" BOOM AND CRUMBER
ASSEMBLY #89282



TRENCHER ASSEMBLY

36" BOOM AND CRUMBER
ASSEMBLY #89282

<u>NO</u>	<u>REQ'D</u>	<u>PART NO.</u>	<u>DESCRIPTION</u>
1	4	1101	.50" UNC x 4.50" Hex Capscrew
2	16	1646	.50" Hard Flat Washer
3	4	1841	.50" UNC Lock Nut
4	4	21061	Lever Arm
5	4	1514	.38" Flat Washer
6	1	89278	Crumber End
7	2	1226	.38" UNC Hex Nut
8	2	1503	.38" Lock Washer
9	2	1044	.38" UNC x 1.25" Hex Capscrew
10	2	54067*	Idler Spacer
11	1	79103*	Idler Wheel
12	1	8085*	Idler Bearing
13	1	53988*	Idler Bearing Hub
14	2	40161	Decal - Stand Clear
15	1	89276	36" Crumber Bar / Personal Restraint Bar
16	2	53138	Boom Bushing
17	1	79085	36" Boom
18	1	53188	Spring
19	1	53132	1.12" Square Pin
20	1	62717	Boom End
21	1	1548	.75" UNC x 1.25" Nylock Capscrew
22	2	62702	Adjusting Bolt
23	2	1245	.75" UNC Jam Nut
24	2	1231	.75" UNC Nut

NOTE: Idler Roller Assembly Repair Kit #80868 includes all parts marked with an asterisk (*).

TRENCHER ASSEMBLY

42" BOOM AND CRUMBER
ASSEMBLY #89283

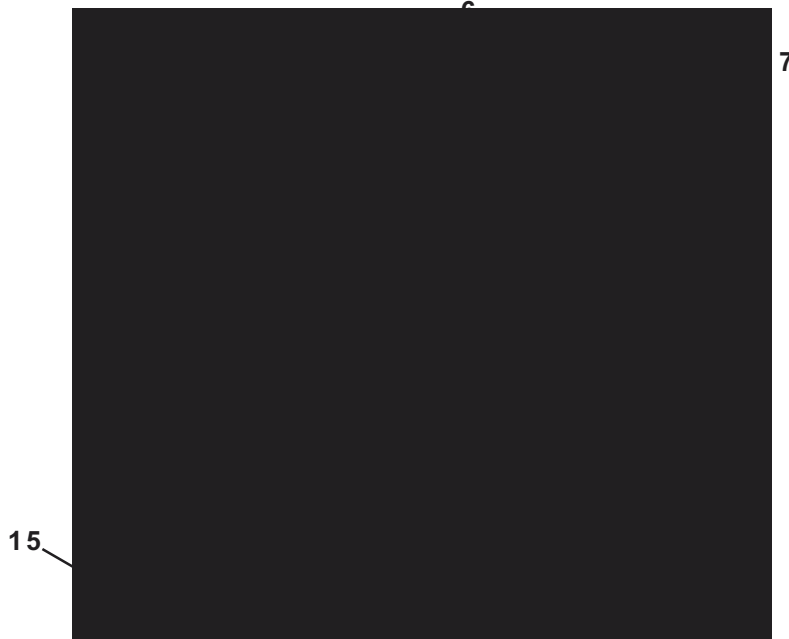

TRENCHER ASSEMBLY

42" BOOM AND CRUMBER
ASSEMBLY #89283

<u>NO</u>	<u>REQ'D</u>	<u>PART NO.</u>	<u>DESCRIPTION</u>
1	4	1101	.50" UNC x 4.50" Hex Capscrew
2	16	1646	.50" Hard Flat Washer
3	4	1841	.50" UNC Lock Nut
4	4	21061	Lever Arm
5	4	1514	.38" Flat Washer
6	1	89278	Crumber End
7	2	1226	.38" UNC Hex Nut
8	2	1503	.38" Lock Washer
9	2	1044	.38" UNC x 1.25" Hex Capscrew
10	2	54067*	Idler Spacer
11	1	79103*	Idler Wheel
12	1	8085*	Idler Bearing
13	1	53988*	Idler Bearing Hub
14	2	40161	Decal - Stand Clear
15	1	21045	42" Crumber Bar / Personal Restraint Bar
16	2	53138	Boom Bushing
17	1	82124	42" Boom
18	1	53188	Spring
19	1	53132	1.12" Square Pin
20	1	62717	Boom End
21	1	1548	.75" UNC x 1.25" Nylock Capscrew
22	2	62702	Adjusting Bolt
23	2	1245	.75" UNC Jam Nut
24	2	1231	.75" UNC Nut

NOTE: Idler Roller Assembly Repair Kit #80868 includes all parts marked with an asterisk (*).

8287
12-12-00

TRENCHER ASSEMBLY

48" BOOM AND CRUMBER
ASSEMBLY #89284



TRENCHER ASSEMBLY

48" BOOM AND CRUMBER
ASSEMBLY #89284

<u>NO</u>	<u>REQ'D</u>	<u>PART NO.</u>	<u>DESCRIPTION</u>
1	4	1101	.50" UNC x 4.50" Hex Capscrew
2	16	1646	.50" Hard Flat Washer
3	4	1841	.50" UNC Lock Nut
4	4	21061	Lever Arm
5	4	1514	.38" Flat Washer
6	1	89278	Crumber End
7	2	1226	.38" UNC Hex Nut
8	2	1503	.38" Lock Washer
9	2	1044	.38" UNC x 1.25" Hex Capscrew
10	2	54067*	Idler Spacer
11	1	79103*	Idler Wheel
12	1	8085*	Idler Bearing
13	1	53988*	Idler Bearing Hub
14	2	40161	Decal - Stand Clear
15	1	21045	48" Crumber Bar / Personal Restraint Bar
16	2	53138	Boom Bushing
17	1	79088	48" Boom
18	1	53188	Spring
19	1	53132	1.12" Square Pin
20	1	62717	Boom End
21	1	1548	.75" UNC x 1.25" Nylock Capscrew
22	2	62702	Adjusting Bolt
23	2	1245	.75" UNC Jam Nut
24	2	1231	.75" UNC Nut

NOTE: Idler Roller Assembly Repair Kit #80868 includes all parts marked with an asterisk (*).

DIGGING CHAIN OPTIONS

GENERAL INFORMATION

This section is devoted to digging chain options for your trencher. In it you will find a listing of all the chain options available. You will also find information on replacement parts, chain assembly, and chain conversion. These options will increase the flexibility of your equipment, and make your trenching job easier.

There is some basic information about the trencher and its digging components that you should know before you try to order any options. This information is given here for your convenience. With it you will be able to better understand the rest of this section.

CHAIN PITCH

The digging chains may be divided into groups by pitch. The pitch of the chain is the distance between the centers of the holes in the chain links (See Figure 1). The word pitch can also be used to describe the length of the chain.

FIGURE #1



**DISTANCE BETWEEN HOLE
CENTERS = PITCH**

FIGURE #2



The 625 Trencher has a heavy weight chain with a tensile strength of 50,000 pounds and a pitch of 2.00".

There is one thing that you must understand about chain pitch. You can not intermix components of different pitches. You cannot substitute chain links of different pitches in a digging chain. Nor can you use a digging chain of one pitch, with a driver sprocket of a different pitch. Attempting to do so will cause the chain to "jump" off the sprocket continuously.

DIGGING CHAIN OPTIONS

COMPONENT SIZE

The size of the digging component is based on the depth of the trench it will dig with auger at ground level and a 60° boom digging angle (See Figure 3). For example, a 36" boom is not necessarily 36" long. The 36" length means it will dig a trench 36" deep with the augers in their float position and at a 60° digging angle.

FIGURE #3



DIGGING STATIONS

Digging chains are made up of a series of individual links pinned together. Every link has a special "Digging Station" link. These links are designed so that the digging teeth can be attached to the basic chains (See Figure 4). Digging chains may be purchased in any length, with or without teeth. All chains, teeth, spacers and assorted digging hardware may be purchased separately.

FIGURE #4



This completes the basic information on digging chain options. The rest of this section contains specific information on digging chains and parts available, complete with part numbers. Again it may be noted that these options are designed to increase the flexibility of your equipment and to make your trenching jobs easier. We offer them to better serve your trenching needs.

DIGGING CHAIN OPTIONS

2.00" PITCH DIGGING CHAIN ASSEMBLIES

GENERAL INFORMATION

This page contains a listing of all of the 2.00" pitch digging chain assemblies offered for your trencher. Each chain assembly comes with all necessary teeth and spacers already installed. Just thread the chain onto the trencher and fasten the two ends together with the pin and keeper pin included in the assembly. A crumber shoe of the appropriate width is also included in the chain assembly.

Before you order a new chain, be sure to check for compatibility with corresponding components. You may need to order more than just a chain assembly. You must use a digging boom of the same digging depth as the chain. The crumber bar must also be of the same digging depth. The digging sprocket must also be of the same pitch as the chain. All of these components must match for the trencher to function properly.

Bare 2.00" pitch digging chain (without teeth, spacers, or hardware) can be ordered in any desired length under the part number 79018. Just use this number and then specify the length desired in pitches (example, 54 pitches of chain would be needed for a 36" boom).

2.00" PITCH DIGGING CHAIN ASSEMBLIES				
Complete chain assemblies. Includes chain with all teeth and spacers attached. Also includes appropriate width crumber shoe.				
CHAIN ASSEMBLIES WITH A TOOTH EVERY STATION				
DESCRIPTION (boom used X trench width)	LENGTH OF CHAIN (in 2.00" pitches)	TENSIL STRENGTH	PART NO.	
For 30" Boom	6" Wide	48 Pitch	50,000#	79154
For 30" Boom	8" Wide	48 Pitch	50,000#	79155
For 30" Boom	10" Wide	48 Pitch	50,000#	79156
For 30" Boom	12" Wide	48 Pitch	50,000#	79157
For 36" Boom	6" Wide	54 Pitch	50,000#	79099
For 36" Boom	8" Wide	54 Pitch	50,000#	79100
For 36" Boom	10" Wide	54 Pitch	50,000#	79158
For 42" Boom	6" Wide	62 Pitch	50,000#	82114
For 42" Boom	8" Wide	62 Pitch	50,000#	82115
For 42" Boom	10" Wide	62 Pitch	50,000#	82116
For 48" Boom	6" Wide	68 Pitch	50,000#	79101
For 48" Boom	8" Wide	68 Pitch	50,000#	79102

DIGGING CHAIN OPTIONS

2.00" PITCH DIGGING CHAIN ASSEMBLIES

2.00" PITCH DIGGING CHAIN ASSEMBLIES					
Complete chain assemblies. Includes chain with all teeth and spacers attached. Also includes appropriate width crumber shoe.					
CHAIN ASSEMBLIES WITH A TOOTH EVERY OTHER STATION					
DESCRIPTION (boom used X trench width)	LENGTH OF CHAIN (in 2.00" pitches)	TENSIL STRENGTH	PART NO.		
For 30" Boom	6" Wide	48 Pitch	50,000#	79181	
For 30" Boom	8" Wide	48 Pitch	50,000#	79182	
For 30" Boom	10" Wide	48 Pitch	50,000#	79183	
For 30" Boom	12" Wide	48 Pitch	50,000#	79184	
For 36" Boom	6" Wide	54 Pitch	50,000#	79185	
For 36" Boom	8" Wide	54 Pitch	50,000#	79186	
For 36" Boom	10" Wide	54 Pitch	50,000#	79187	
For 42" Boom	6" Wide	62 Pitch	50,000#	82117	
For 42" Boom	8" Wide	62 Pitch	50,000#	82118	
For 42" Boom	10" Wide	62 Pitch	50,000#	82119	
For 48" Boom	6" Wide	68 Pitch	50,000#	79188	
For 48" Boom	8" Wide	68 Pitch	50,000#	79189	

70/30 COMBINATION CHAIN ASSEMBLIES					
DESCRIPTION (boom used X trench width)	LENGTH OF CHAIN (in 2.00" pitches)	TENSIL STRENGTH	PART NO.		
For 30" Boom	6" Wide	48 Pitch	50,000#	31546	
For 36" Boom	6" Wide	54 Pitch	50,000#	31547	
For 42" Boom	6" Wide	62 Pitch	50,000#	31563	
For 48" Boom	6" Wide	68 Pitch	50,000#	31548	

COMBINATION CHAIN ASSEMBLIES WITH 50/50 R&F/CUP TEETH					
DESCRIPTION (boom used X trench width)	LENGTH OF CHAIN (in 2.00" pitches)	TENSIL STRENGTH	PART NO.		
For 30" Boom	6" Wide	48 Pitch	50,000#	83706	
For 36" Boom	6" Wide	54 Pitch	50,000#	83707	
For 42" Boom	6" Wide	62 Pitch	50,000#	83708	
For 48" Boom	6" Wide	68 Pitch	50,000#	83709	

SHARK STYLE TOOTH CHAIN ASSEMBLIES					
DESCRIPTION (boom used X trench width)	LENGTH OF CHAIN (in 2.00" pitches)	TENSIL STRENGTH	PART NO.		
For 30" Boom	6" Wide	48 Pitch	50,000#	31549	
For 36" Boom	6" Wide	54 Pitch	50,000#	31550	
For 42" Boom	6" Wide	62 Pitch	50,000#	31551	
For 48" Boom	6" Wide	68 Pitch	50,000#	31552	

DIGGING CHAIN OPTIONS

2.00" PITCH CHAIN REPLACEMENT PARTS

GENERAL INFORMATION

You can purchase individual chain links and pins for your trencher. These can be used to repair a damaged chain, or lengthen and modify an existing chain. Below is a diagram of the chain's basic components with their descriptions and corresponding part numbers. Use these numbers when ordering. You can also order a complete bare chain (without teeth and spacers) in any length desired. The chain is ordered under part number 79018 for 2.00" Pitch. Just specify the length you want in pitches. (See "2.00" PITCH DIGGING CHAIN ASSEMBLIES" chart located in this section.)

When pinning links of chain together, first tap the pin through the connector link with the perfectly round holes and then on through the inner link. Place the second connector link in position, you will note that the end of the pin has one side flattened. Rotate the pin until its flat side lines up with the corresponding flat side of the connector link hole and tap the pin on through. Place the chain keeper pin into the hole at the end of the main pin and tap down tight. Finally, bend the end of the keeper pin over to secure it in place.



<u>NO.</u>	<u>REQ'D</u>	<u>PART NO.</u>	<u>DESCRIPTION</u>
1	Varies	54757	Inner Link
2	Varies	54731	Pin
3	Varies	54732	Chain Keeper Pin
4	Varies	54730	Connector Link includes (2) Pins #54731 and (2) Chain Keeper Pins #54732

DIGGING CHAIN OPTIONS

2.00" PITCH DIGGING CHAIN TOOTH STATION SEQUENCE

GENERAL INFORMATION

Every second link on a digging chain is a special link called a digging station. These digging station links are designed so that digging teeth can be bolted onto them in a variety of configurations. It is the number and the make up of these different digging stations that make each chain unique.

The following pages show the various chains available for 2.00" pitch trenchers. The digging tooth make up of each digging station is given in code. The key to the code is listed below. Thus the chain assembly diagrams will show you the order of the digging stations on each digging chain. The actual parts break down of each digging tooth station is also shown on the following pages.

C-D	CENTER SHARK STYLE TOOTH
CL-C	CENTER LEFT CUP TOOTH
CL-D	CENTER LEFT SHARK STYLE TOOTH
CR-C	CENTER RIGHT CUP TOOTH
CR-D	CENTER RIGHT SHARK STYLE TOOTH
6L-C.....	6" LEFT CUP TOOTH
6L-D.....	6" LEFT SHARK STYLE TOOTH
6R-C	6" RIGHT CUP TOOTH
6R-D	6" RIGHT SHARK STYLE TOOTH
8L-C.....	8" LEFT CUP TOOTH
8L-D.....	8" LEFT SHARK STYLE TOOTH
8R-C	8" RIGHT CUP TOOTH
8R-D	8" RIGHT SHARK STYLE TOOTH
10-C.....	10" CUP TOOTH
10-D.....	10" SHARK STYLE TOOTH
12-C.....	12" CUP TOOTH
12-D.....	12" SHARK STYLE TOOTH

DIGGING CHAIN OPTIONS

2.00" PITCH DIGGING STATIONS

CUP TOOTH DIGGING STATIONS

CL-C

CR-C

6L-C

6R-C

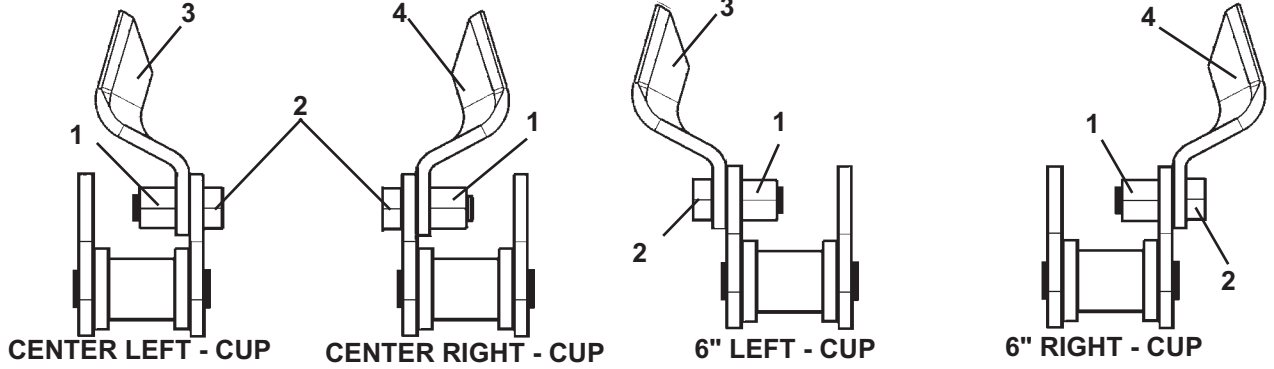

8L-C

8R-C

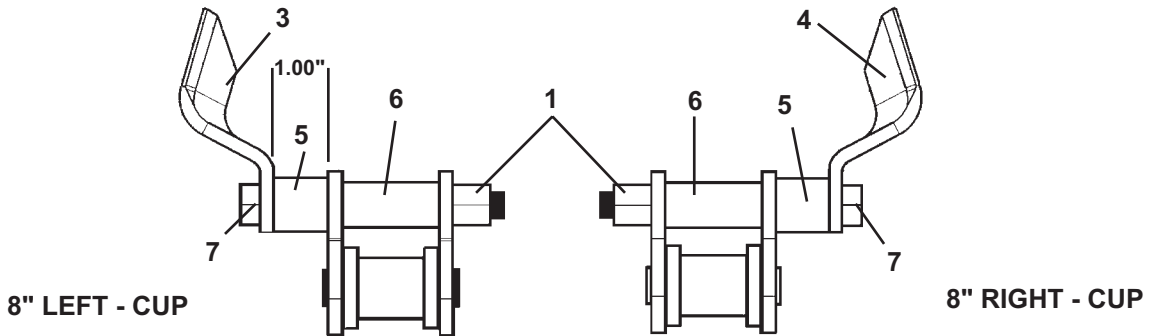

10-C

10" - CUP

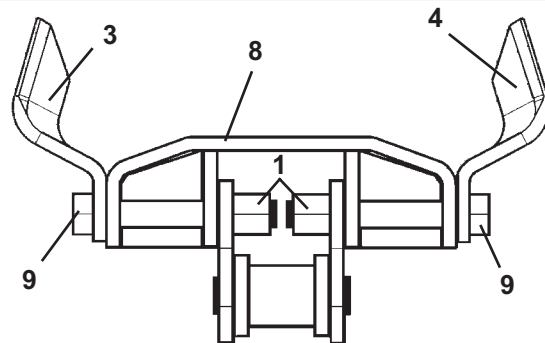

12-C

12" - CUP

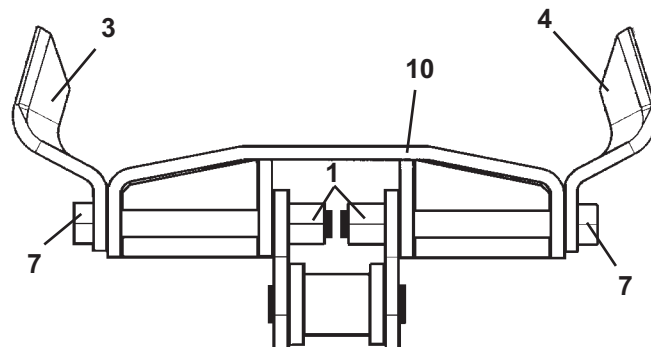

DIGGING CHAIN OPTIONS

2.00" PITCH DIGGING STATIONS

CUP TOOTH DIGGING STATIONS

<u>NO</u>	<u>PART NO.</u>	<u>DESCRIPTION</u>
1	1692	.50" UNF Nut
2	1340	.50" UNF X 1.50" Hex Capscrew
3	54431	Left Cup Tooth
4	54432	Right Cup Tooth
5	54439	Tooth Spacer
6	54440	Spacer 1.81"
7	1351	.50" UNF X 4.50" Hex Capscrew
8	54441	10" Tooth Spacer
9	1347	.50" UNF X 3.25" Hex Capscrew
10	54442	12" Tooth Spacer

DIGGING CHAIN OPTIONS

2.00" PITCH DIGGING STATIONS

SHARK STYLE TOOTH DIGGING STATIONS

C-D CL-D CR-D 6L-D 6R-D

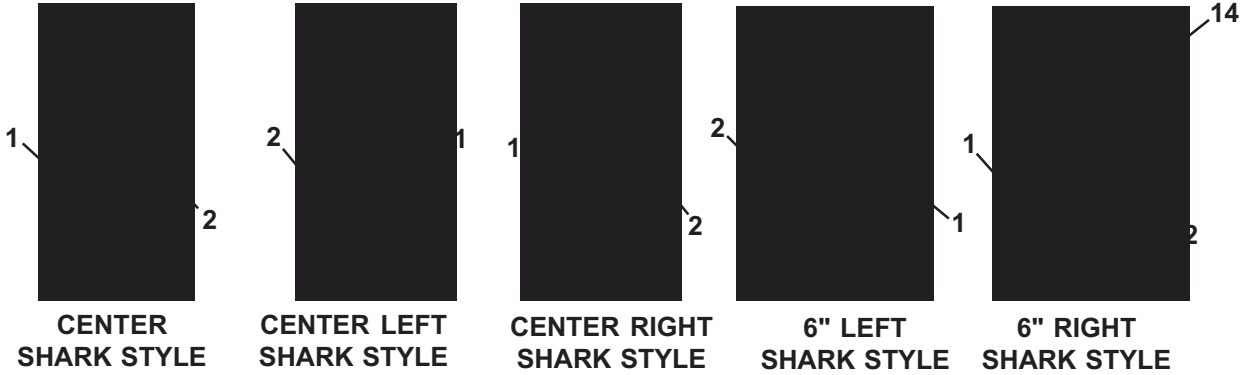

8L-D 8R-D 8-D

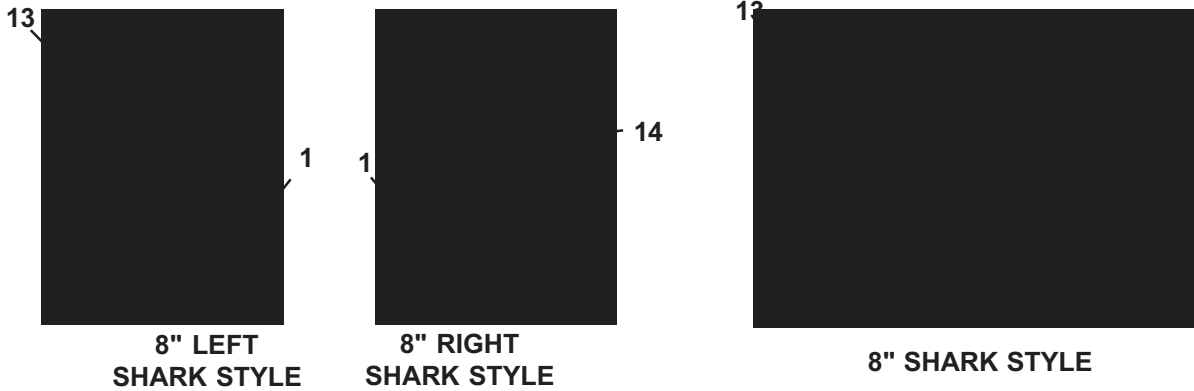

10-D



12-D



DIGGING CHAIN OPTIONS

2.00" PITCH DIGGING STATIONS

SHARK STYLE TOOTH DIGGING STATIONS

<u>NO</u>	<u>PART NO.</u>	<u>DESCRIPTION</u>
1	1692	.50" UNF Hex Nut
2	22321	.50" UNF X 3.00" Hex Capscrew - Grade 8
3	54440	Spacer
4	22324	.50" UNF X 4.50" Hex Capscrew - Grade 8
5	54439	Tooth Spacer
6	1814	.50" UNF X 6.00" Hex Capscrew - Grade 8
7	22322	.50" UNF X 3.50" Hex Capscrew - Grade 8
8	54441	10" Tooth Spacer
9	54442	12" Tooth Spacer
10	31599	Center Shark Style Tooth
11	15053	Spacer
12	15054	Spacer
13	31600	Left Shark Style Tooth
14	31601	Right Shark Style Tooth

COMBINATION ROCK AND FROST CHAIN

2.00" PITCH - TOOTH EVERY STATION
SERVICEPARTS

STATION #1 **STATION #2** **STATION #3**

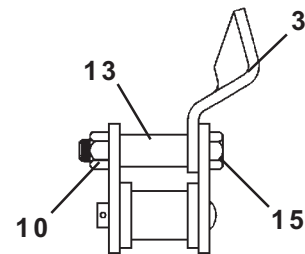
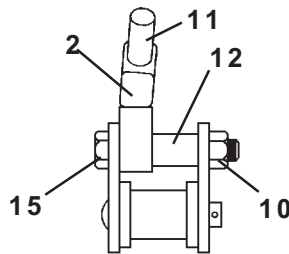
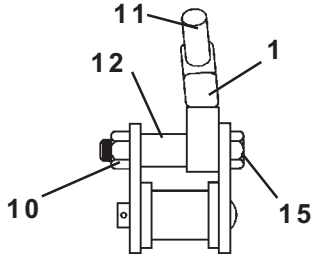

STATION #4 **STATION #5** **STATION #6**

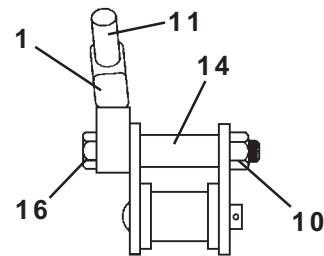
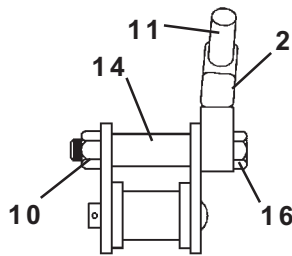
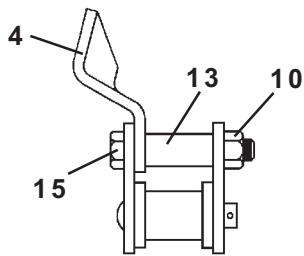

STATION #7 **STATION #8** **STATION #9**

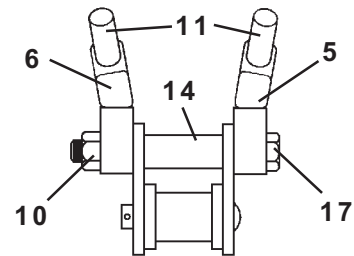
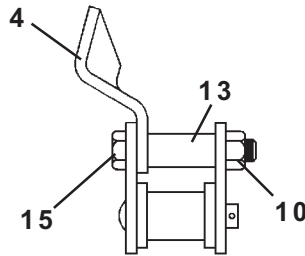
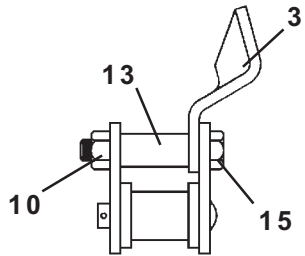

STATION #10 **STATION #11** **STATION #12**

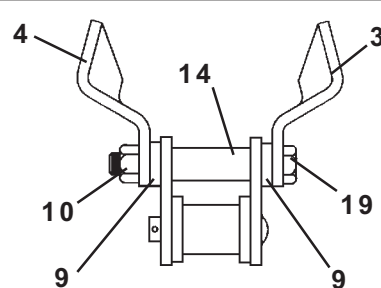
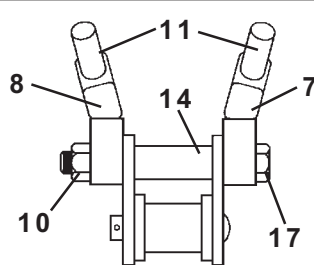
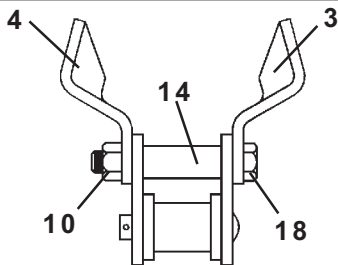

COMBINATION ROCK AND FROST CHAIN

2.00" PITCH - TOOTH EVERY STATION
SERVICEPARTS

<u>NO</u>	<u>PART NO.</u>	<u>DESCRIPTION</u>
1	83802	Carbide Bit Holder - 4" Right
2	83801	Carbide Bit Holder - 4" Left
3	54432	Cup Cutter - Right
4	54431	Cup Cutter - Left
5	83804	Carbide Bit Holder - 5" Right (1) Weld Spot on Top for Identifying Purposes
6	83803	Carbide Bit Holder - 5" Left (1) Weld Spot on Top for Identifying Purposes
7	83806	Carbide Bit Holder - 6" Right (2) Weld Spots on Top for Identifying Purposes
8	83805	Carbide Bit Holder - 6" Left (2) Weld Spots on Top for Identifying Purposes
9	83800	Spacer - 6" Cut
10	1692	.50" UNF Hex Nut
11	51547	Carbide Bit
12	83798	Tube Spacer (Inside Mount Carbide Bit Holder)
13	54628	Tube Spacer (Inside Mount Cup Cutter)
14	54440	Tube Spacer (Outside Cup or Carbide Bit Holder)
15	1347	.50" UNF X 3.25" Hex Capscrew
16	1349	.50" UNF X 3.75" Hex Capscrew
17	1351	.50" UNF X 4.50" Hex Capscrew
18	1348	.50" UNF X 3.50" Hex Capscrew
19	1350	.50" UNF X 4.00" Hex Capscrew

NOTE: There are weld spots located on the top of the 5" and 6" Carbide Bit Holders to assist in parts identification. One weld spot on the 5" Holders and two weld spots on the 6" Holders.

DIGGING CHAIN OPTIONS

30" BOOM AND CUP TEETH EVERY STATION

#79154

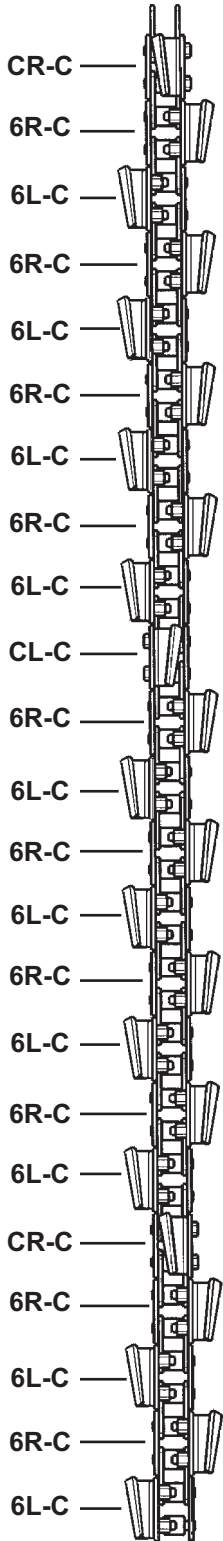

#79155

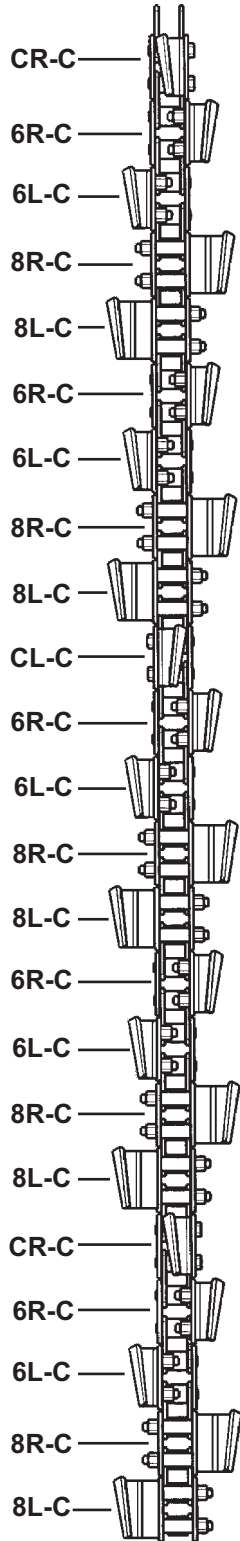

#79156

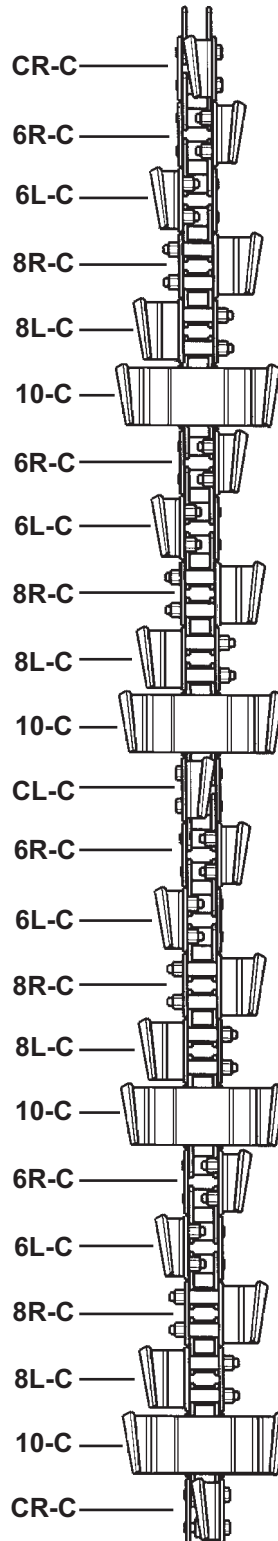

#79157

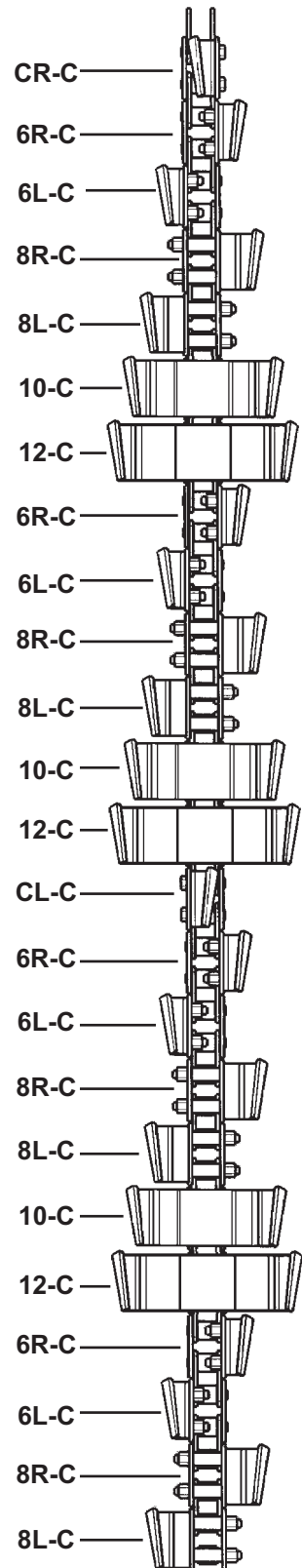

DIGGING CHAIN OPTIONS

42" BOOM AND CUP TEETH EVERY STATION

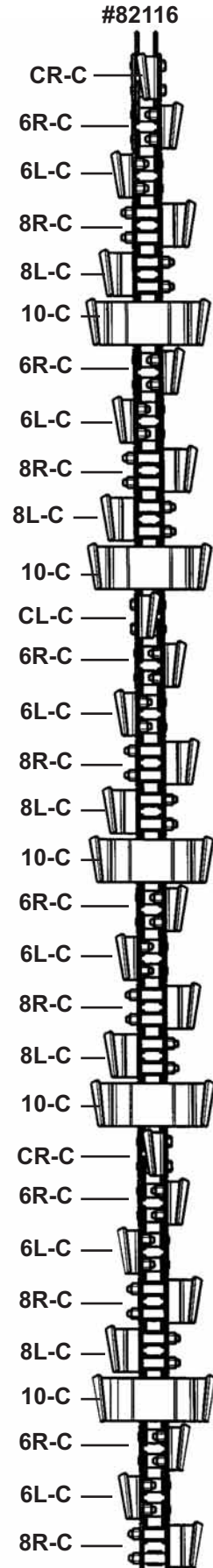
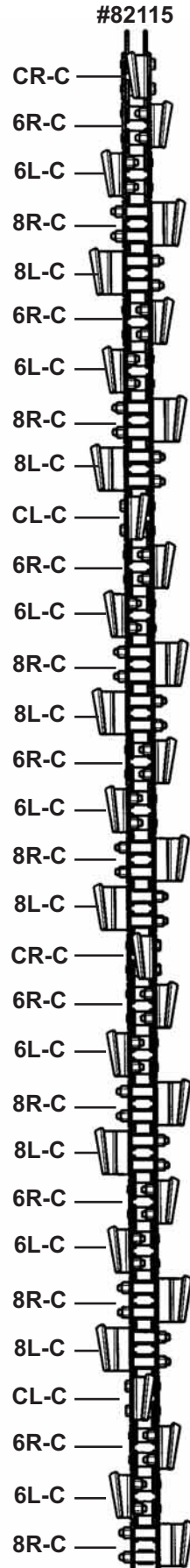
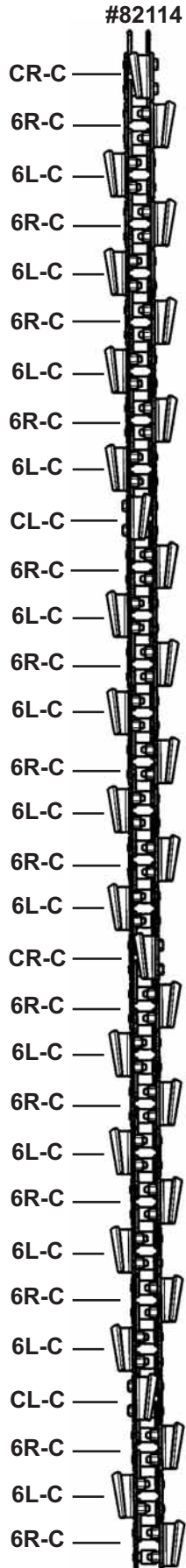

DIGGING CHAIN OPTIONS

30" BOOM AND CUP TEETH EVERY OTHER STATION

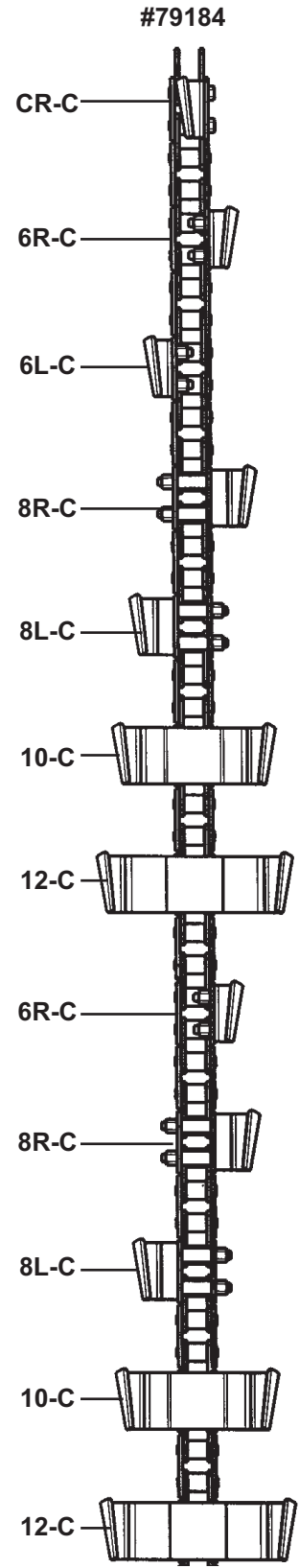
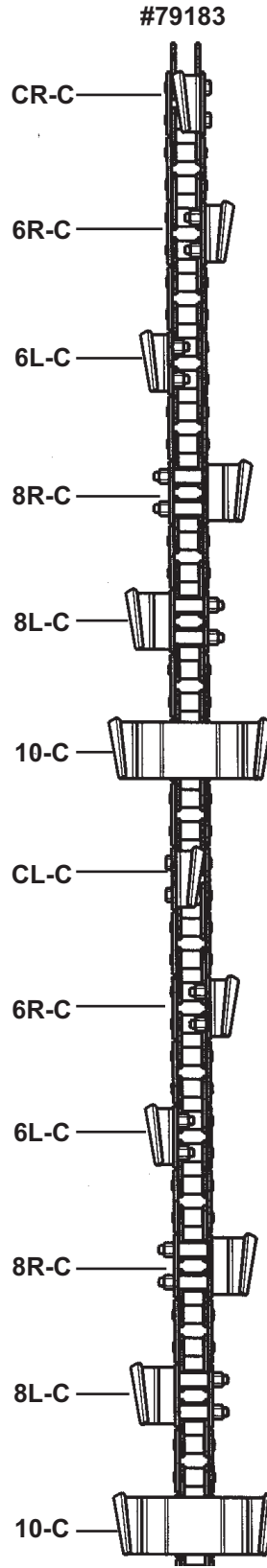
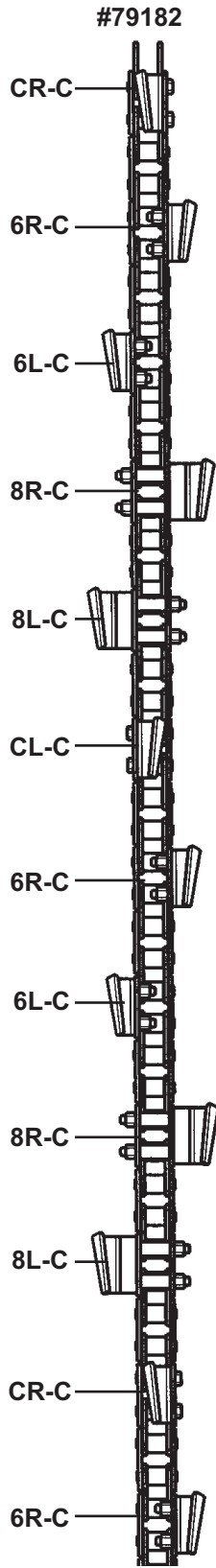
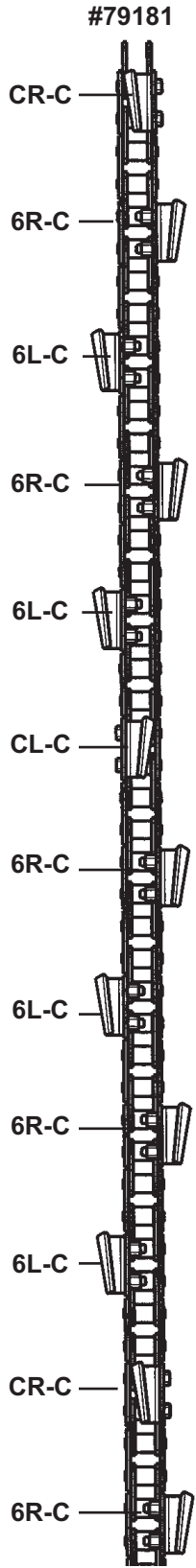

DIGGING CHAIN OPTIONS

36" BOOM AND CUP TEETH EVERY OTHER STATION

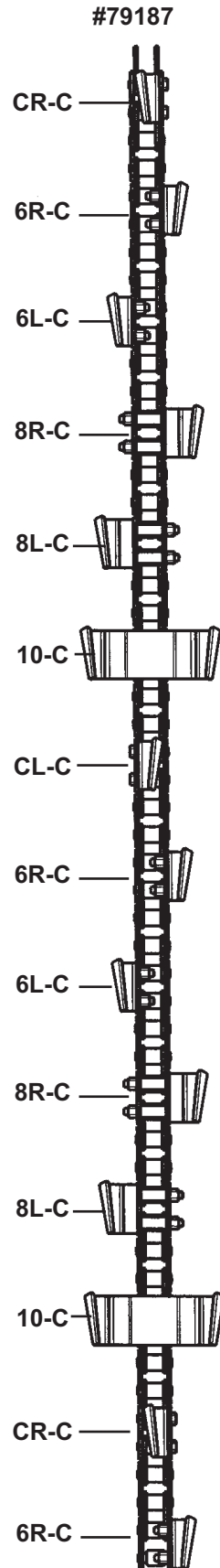
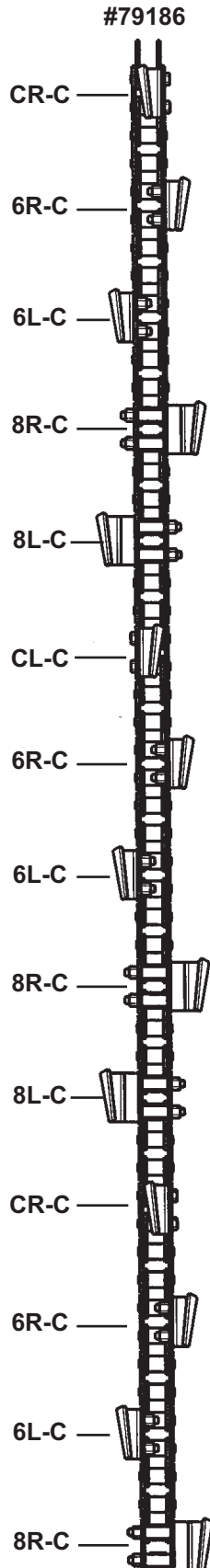
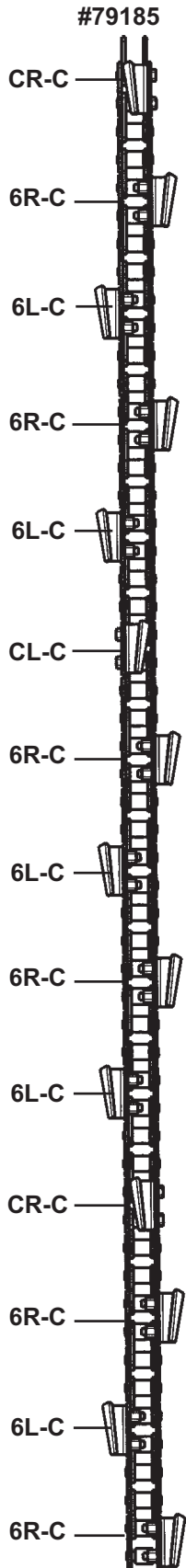

DIGGING CHAIN OPTIONS

42" BOOM AND CUP TEETH EVERY OTHER STATION

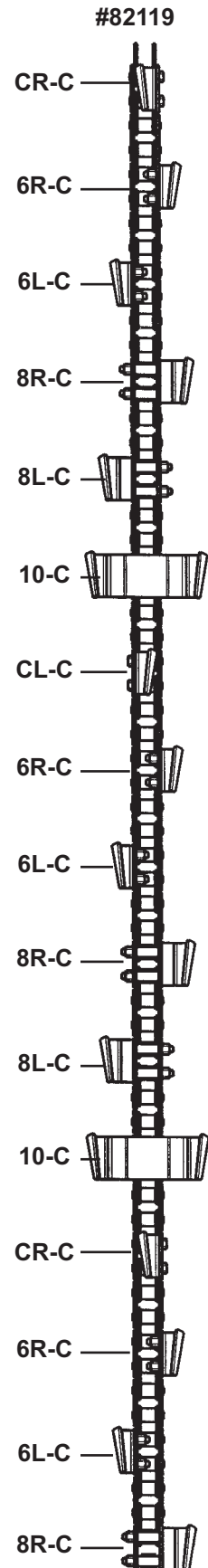
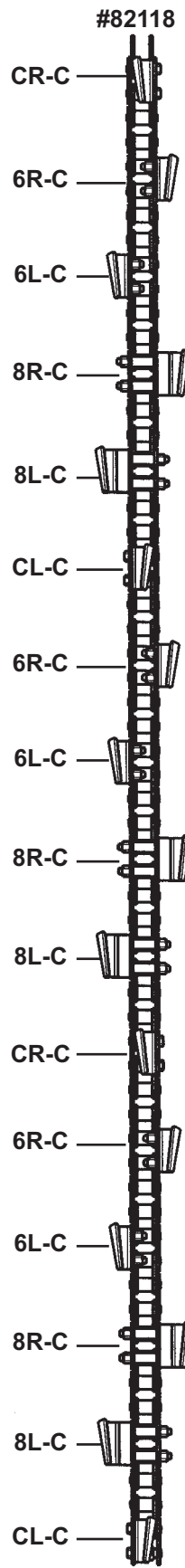
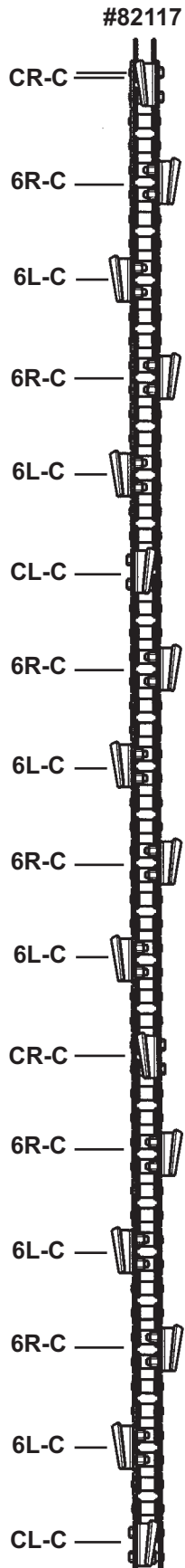

DIGGING CHAIN OPTIONS

48" BOOM AND CUP TEETH EVERY OTHER STATION

#79188

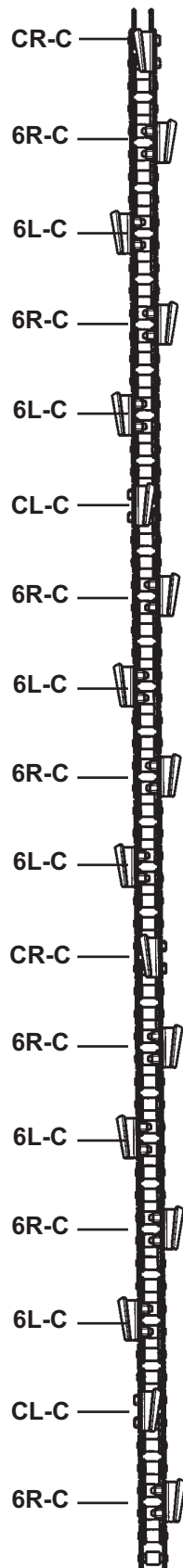

#79189

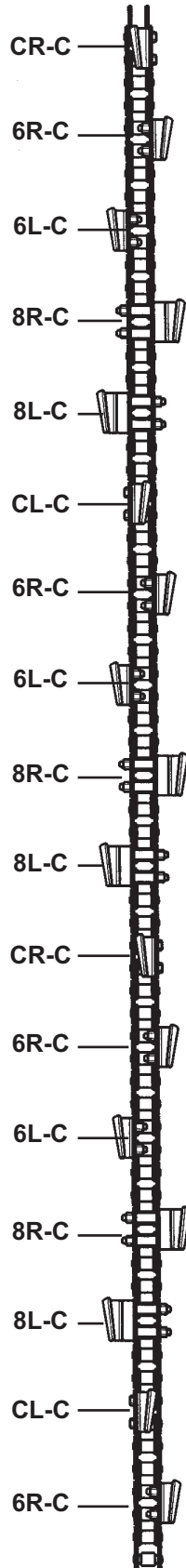

DIGGING CHAIN OPTIONS

60" BOOM AND CUP TEETH EVERY OTHER STATION

#80043

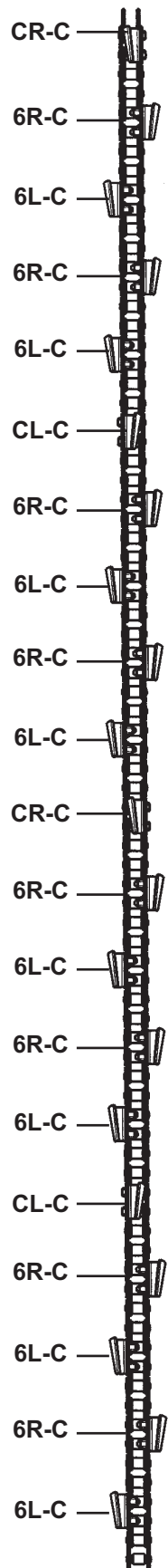

DIGGING CHAIN OPTIONS

70/30 COMBINATION CHAINS

(AGGRESSIVE SHARK-STYLE TEETH - CUP TEETH)

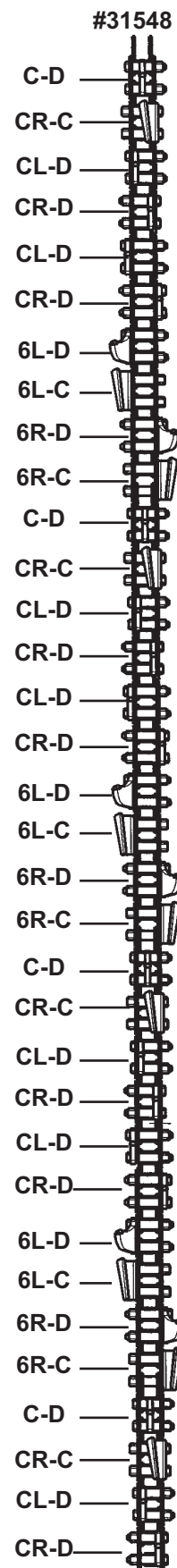
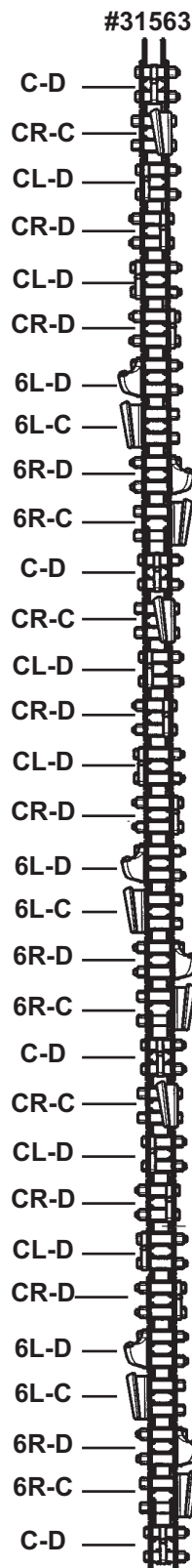
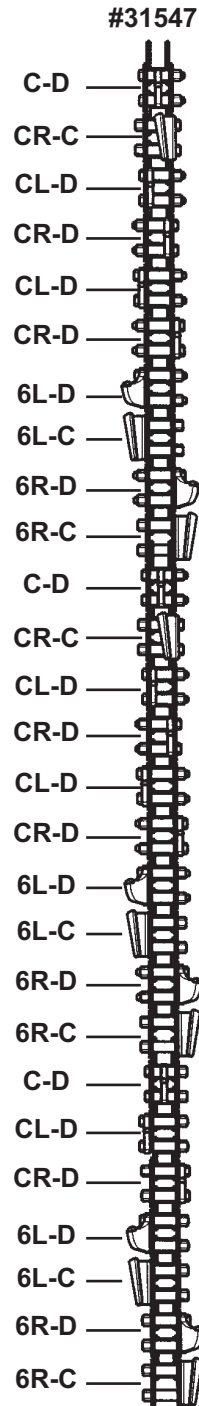
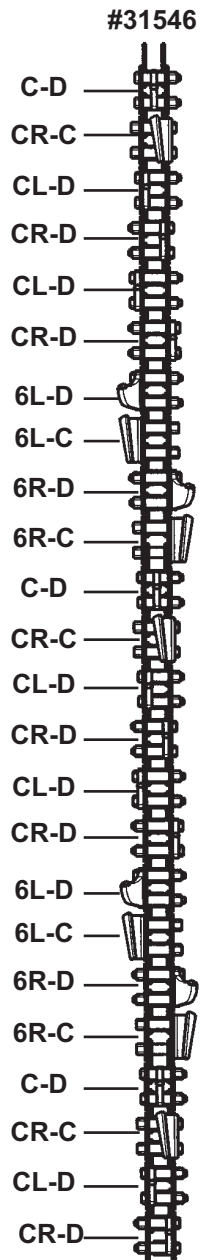

DIGGING CHAIN OPTIONS

2.00" PITCH DIGGING CHAIN WIDTH CONVERSIONS

GENERAL INFORMATION

Digging chains can be modified to dig trenches in a variety of widths. By modifying an existing chain, it can be used to dig the width you want and thus save going the expense of a whole new digging chain assembly. This can be a considerable cost savings, however it is more work than just installing a new digging chain assembly.

The information given below is a complete listing of all the possible chain width conversions for 2.00" pitch chain for your trencher. Included in the listing is a break down of all the parts (including part numbers and quantities) needed to make the conversion. Simply install the new parts (and rearrange the old parts) so that the finished chain construction follows that described in the "Digging Tooth Station Sequence" chart and the "Digging Tooth Station Break Down" diagrams for 2.00" pitch chain (located elsewhere in this section).

It should be noted that this information only applies to modifying chains of the same length and pitch. All components must be of the same pitch. You cannot intermix components of different pitch.

CHAIN CONVERSIONS FOR 30" BOOMS - TOOTH EVERY STATION

1) FROM 6" WIDE TO 8" WIDE

<u>REQ'D</u>	<u>PART NO.</u>	<u>DESCRIPTION</u>
20	1351	.50"UNF X 4.50" Capscrew
20	54440	Spacer Tube
10	54439	8" Spacer
1	53055	8" Crumber Shoe

2) FROM 8" WIDE TO 6" WIDE

<u>REQ'D</u>	<u>PART NO.</u>	<u>DESCRIPTION</u>
20	1340	.50"UNF X 1.50" Capscrew
1	53054	6" Crumber Shoe

3) FROM 6" WIDE TO 10" WIDE

<u>REQ'D</u>	<u>PART NO.</u>	<u>DESCRIPTION</u>
8	1692	.50" UNF High Hex Nut
16	1347	.50"UNF X 3.25" Capscrew
16	1351	.50"UNF X 4.50" Capscrew
2	54431	Left Tooth
2	54432	Right Tooth
16	54440	Spacer Tube
4	54441	10" Chain Spacer
1	53058	10" Crumber Shoe
8	54439	8" Spacer

DIGGING CHAIN OPTIONS

2.00" PITCH DIGGING CHAIN WIDTH CONVERSIONS

4) FROM 10" WIDE TO 6" WIDE

<u>REQ'D</u>	<u>PART NO.</u>	<u>DESCRIPTION</u>
24	1340	.50"UNF X 1.50" Capscrew
1	53054	6" Crumber Shoe

5) FROM 6" WIDE TO 12" WIDE

<u>REQ'D</u>	<u>PART NO.</u>	<u>DESCRIPTION</u>
12	1692	.50" UNF High Hex Nut
28	1351	.50"UNF X 4.50" Capscrew
12	1347	.50"UNF X 3.25" Capscrew
3	54431	Left Tooth
3	54432	Right Tooth
3	54441	10" Chain Spacer
3	54442	12" Chain Spacer
1	53059	12" Crumber Shoe
8	54439	8" Spacer
16	54440	Spacer Tube

6) FROM 12" WIDE TO 6" WIDE

<u>REQ'D</u>	<u>PART NO.</u>	<u>DESCRIPTION</u>
16	1340	.50"UNF X 1.50" Capscrew
1	53054	6" Crumber Shoe

7) FROM 8" WIDE TO 10" WIDE

<u>REQ'D</u>	<u>PART NO.</u>	<u>DESCRIPTION</u>
8	1692	.50" UNF High Hex Nut
16	1347	.50"UNF X 3.25" Capscrew
2	54431	Left Tooth
2	54432	Right Tooth
4	54441	10" Chain Spacer
1	53058	10" Crumber Shoe

8) FROM 10" WIDE TO 8" WIDE

<u>REQ'D</u>	<u>PART NO.</u>	<u>DESCRIPTION</u>
4	1351	.50"UNF X 4.50" Capscrew
4	1340	.50" UNF X 1.50" Capscrew
2	54439	8" Spacer
1	53055	8" Crumber Shoe

DIGGING CHAIN OPTIONS

2.00" PITCH DIGGING CHAIN WIDTH CONVERSIONS

9) FROM 8" WIDE TO 12" WIDE

<u>REQ'D</u>	<u>PART NO.</u>	<u>DESCRIPTION</u>
12	1692	.50" UNF High Hex Nut
12	1347	.50"UNF X 3.25" Capscrew
8	1351	.50"UNF X 4.50" Capscrew
3	54431	Left Tooth
3	54432	Right Tooth
3	54441	10" Chain Spacer
3	54442	12" Chain Spacer
1	53059	12" Crumber Shoe

10) FROM 12" WIDE TO 8" WIDE

<u>REQ'D</u>	<u>PART NO.</u>	<u>DESCRIPTION</u>
8	1340	.50" UNF X 1.50" Capscrew
4	54440	Spacer Tube
2	54439	8" Spacer
1	53055	8" Crumber Shoe

11) FROM 10" WIDE TO 12" WIDE

<u>REQ'D</u>	<u>PART NO.</u>	<u>DESCRIPTION</u>
4	1692	.50" UNF High Hex Nut
12	1351	.50"UNF X 4.50" Capscrew
1	54431	Left Tooth
1	54432	Right Tooth
3	54442	12" Chain Spacer
1	53059	12" Crumber Shoe

12) FROM 12" WIDE TO 10" WIDE

<u>REQ'D</u>	<u>PART NO.</u>	<u>DESCRIPTION</u>
8	1347	.50"UNF X 3.25" Capscrew
4	1340	.50" UNF X 1.50" Capscrew
1	54441	10" Chain Spacer
1	53058	10" Crumber Shoe

CHAIN CONVERSIONS FOR 36" BOOMS - TOOTH EVERY STATION**1) FROM 6" WIDE TO 8" WIDE**

<u>REQ'D</u>	<u>PART NO.</u>	<u>DESCRIPTION</u>
24	1351	.50"UNF X 4.50" Capscrew
24	54440	Spacer Tube
12	54439	8" Spacer
1	53055	8" Crumber Shoe

DIGGING CHAIN OPTIONS

2.00" PITCH DIGGING CHAIN WIDTH CONVERSIONS

2) FROM 8" WIDE TO 6" WIDE

<u>REQ'D</u>	<u>PART NO.</u>	<u>DESCRIPTION</u>
24	1340	.50"UNF X 1.50" Capscrew
1	53054	6" Crumber Shoe

3) FROM 6" WIDE TO 10" WIDE

<u>REQ'D</u>	<u>PART NO.</u>	<u>DESCRIPTION</u>
8	1692	.50" UNF High Hex Nut
16	1347	.50" UNF X 3.25" Capscrew
20	1351	.50"UNF X 4.50" Capscrew
2	54431	Left Tooth
2	54432	Right Tooth
4	54441	10" Chain Spacer
1	53058	10" Crumber Shoe
10	54439	8" Spacer
20	54440	Spacer Tube

4) FROM 10" WIDE TO 6" WIDE

<u>REQ'D</u>	<u>PART NO.</u>	<u>DESCRIPTION</u>
28	1340	.50"UNF X 1.50" Capscrew
1	53054	6" Crumber Shoe

5) FROM 8" WIDE TO 10" WIDE

<u>REQ'D</u>	<u>PART NO.</u>	<u>DESCRIPTION</u>
8	1692	.50" UNF High Hex Nut
16	1347	.50"UNF X 3.25" Capscrew
2	54431	Left Tooth
2	54432	Right Tooth
4	54441	10" Chain Spacer
1	53058	10" Crumber Shoe

6) FROM 10" WIDE TO 8" WIDE

<u>REQ'D</u>	<u>PART NO.</u>	<u>DESCRIPTION</u>
4	1351	.50"UNF X 4.50" Capscrew
4	1340	.50" UNF X 1.50" Capscrew
4	54440	Spacer Tube
2	54439	8" Spacer
1	53055	8" Crumber Shoe

DIGGING CHAIN OPTIONS

2.00" PITCH DIGGING CHAIN WIDTH CONVERSIONS

CHAIN CONVERSIONS FOR 42" BOOMS - TOOTH EVERY STATION**1) FROM 6" WIDE TO 8" WIDE**

<u>REQ'D</u>	<u>PART NO.</u>	<u>DESCRIPTION</u>
26	1351	.50"UNF X 4.50" Capscrew
26	54440	Spacer Tube
13	54439	8" Spacer
1	53055	8" Crumber Shoe

2) FROM 8" WIDE TO 6" WIDE

<u>REQ'D</u>	<u>PART NO.</u>	<u>DESCRIPTION</u>
26	1340	.50" UNF X 1.50" Capscrew
1	53054	6" Crumber Shoe

3) FROM 6" WIDE TO 10" WIDE

<u>REQ'D</u>	<u>PART NO.</u>	<u>DESCRIPTION</u>
10	1692	.50" UNF High Hex Nut
20	1347	.50" UNC X 3.25" Capscrew
22	1351	.50"UNF X 4.50" Capscrew
2	54431	Left Tooth
3	54432	Right Tooth
5	54441	10" Chain Spacer
1	53058	10" Crumber Shoe
11	54439	8" Spacer
22	54440	Stacer Tube

4) FROM 10" WIDE TO 6" WIDE

<u>REQ'D</u>	<u>PART NO.</u>	<u>DESCRIPTION</u>
32	1340	.50" UNF X 1.50" Capscrew
1	53054	6" Crumber Shoe

5) FROM 8" WIDE TO 10" WIDE

<u>REQ'D</u>	<u>PART NO.</u>	<u>DESCRIPTION</u>
10	1692	.50" UNF High Hex Nut
20	1347	.50"UNF X 3.25" Capscrew
2	54431	Left Tooth
3	54432	Right Tooth
5	54441	10" Chain Spacer
1	53058	10" Crumber Shoe

DIGGING CHAIN OPTIONS

2.00" PITCH DIGGING CHAIN WIDTH CONVERSIONS

6) FROM 10" WIDE TO 8" WIDE

<u>REQ'D</u>	<u>PART NO.</u>	<u>DESCRIPTION</u>
4	1351	.50"UNF X 4.50" Capscrew
6	1340	.50" UNF X 1.50" Capscrew
4	54440	Spacer Tube
2	54439	8" Spacer
1	53055	8" Crumber Shoe

CHAIN CONVERSIONS FOR 48" BOOMS - TOOTH EVERY STATION**1) FROM 6" WIDE TO 8" WIDE**

<u>REQ'D</u>	<u>PART NO.</u>	<u>DESCRIPTION</u>
28	1351	.50"UNF X 4.50" Capscrew
28	54440	Spacer Tube
14	54439	8" Spacer
1	53055	8" Crumber Shoe

2) FROM 8" WIDE TO 6" WIDE

<u>REQ'D</u>	<u>PART NO.</u>	<u>DESCRIPTION</u>
28	1340	.50" UNF X 1.50" Capscrew
1	53054	6" Crumber Shoe

CHAIN CONVERSIONS FOR 30" BOOMS - TOOTH EVERY OTHER STATION**1) FROM 6" WIDE TO 8" WIDE**

<u>REQ'D</u>	<u>PART NO.</u>	<u>DESCRIPTION</u>
8	1351	.50"UNF X 4.50" Capscrew
4	54439	8" Spacer
1	53055	8" Crumber Shoe
8	54440	Spacer Tube

2) FROM 8" WIDE TO 6" WIDE

<u>REQ'D</u>	<u>PART NO.</u>	<u>DESCRIPTION</u>
8	1340	.50" UNF X 1.50" Capscrew
1	53054	6" Crumber Shoe

3) FROM 6" WIDE TO 10" WIDE

<u>REQ'D</u>	<u>PART NO.</u>	<u>DESCRIPTION</u>
4	1692	.50" UNF High Hex Nut
8	1347	.50" UNF X 3.25" Capscrew
8	1351	.50"UNF X 4.50" Capscrew
1	54431	Left Tooth
1	54432	Right Tooth
2	54441	10" Chain Spacer
1	53058	10" Crumber Shoe
4	54439	8" Spacer
8	54440	Spacer Tube

DIGGING CHAIN OPTIONS

2.00" PITCH DIGGING CHAIN WIDTH CONVERSIONS

4) FROM 10" WIDE TO 6" WIDE

<u>REQ'D</u>	<u>PART NO.</u>	<u>DESCRIPTION</u>
12	1340	.50" UNF X 1.50" Capscrew
1	53054	6" Crumber Shoe

5) FROM 6" WIDE TO 12" WIDE

<u>REQ'D</u>	<u>PART NO.</u>	<u>DESCRIPTION</u>
8	1692	.50" UNF High Hex Nut
16	1351	.50"UNF X 4.50" Capscrew
8	1347	.50" UNF X 3.25" Capscrew
2	54431	Left Tooth
2	54432	Right Tooth
2	54441	10" Chain Spacer
2	54442	12" Chain Spacer
1	53059	12" Crumber Shoe
4	54439	8" Spacer
8	54440	Spacer Tube

6) FROM 12" WIDE TO 6" WIDE

<u>REQ'D</u>	<u>PART NO.</u>	<u>DESCRIPTION</u>
16	1340	.50" UNF X 1.50" Capscrew
1	53054	6" Crumber Shoe

7) FROM 8" WIDE TO 10" WIDE

<u>REQ'D</u>	<u>PART NO.</u>	<u>DESCRIPTION</u>
4	1692	.50" UNF High Hex Nut
8	1347	.50"UNF X 3.25" Capscrew
1	54431	Left Tooth
1	54432	Right Tooth
2	54441	10" Chain Spacer
1	53058	10" Crumber Shoe

8) FROM 10" WIDE TO 8" WIDE

<u>REQ'D</u>	<u>PART NO.</u>	<u>DESCRIPTION</u>
4	1340	.50" UNF X 1.50" Capscrew
1	53055	8" Crumber Shoe

DIGGING CHAIN OPTIONS

2.00" PITCH DIGGING CHAIN WIDTH CONVERSIONS

9) FROM 8" WIDE TO 12" WIDE

<u>REQ'D</u>	<u>PART NO.</u>	<u>DESCRIPTION</u>
8	1692	.50" UNF High Hex Nut
8	1347	.50" UNF X 3.25" Capscrew
8	1351	.50"UNF X 4.50" Capscrew
2	54431	Left Tooth
2	54432	Right Tooth
2	54441	10" Chain Spacer
2	54442	12" Chain Spacer
1	53059	12" Crumber Shoe

10) FROM 12" WIDE TO 8" WIDE

<u>REQ'D</u>	<u>PART NO.</u>	<u>DESCRIPTION</u>
8	1340	.50" UNF X 1.50" Capscrew
1	53055	8" Crumber Shoe

11) FROM 10" WIDE TO 12" WIDE

<u>REQ'D</u>	<u>PART NO.</u>	<u>DESCRIPTION</u>
4	1692	.50" UNF High Hex Nut
8	1351	.50"UNF X 4.50" Capscrew
1	54431	Left Tooth
1	54432	Right Tooth
2	54442	12" Chain Spacer
1	53059	12" Crumber Shoe

12) FROM 12" WIDE TO 10" WIDE

<u>REQ'D</u>	<u>PART NO.</u>	<u>DESCRIPTION</u>
4	1340	.50" UNF X 1.50" Capscrew
1	53058	10" Crumber Shoe

CHAIN CONVERSIONS FOR 36" BOOMS - TOOTH EVERY OTHER STATION**1) FROM 6" WIDE TO 8" WIDE**

<u>REQ'D</u>	<u>PART NO.</u>	<u>DESCRIPTION</u>
10	1351	.50"UNF X 4.50" Capscrew
5	54439	8" Spacer
10	54440	Spacer Tube
1	53055	8" Crumber Shoe

2) FROM 8" WIDE TO 6" WIDE

<u>REQ'D</u>	<u>PART NO.</u>	<u>DESCRIPTION</u>
10	1340	.50" UNF X 1.50" Capscrew
1	53054	6" Crumber Shoe

DIGGING CHAIN OPTIONS

2.00" PITCH DIGGING CHAIN WIDTH CONVERSIONS

3) FROM 6" WIDE TO 10" WIDE

<u>REQ'D</u>	<u>PART NO.</u>	<u>DESCRIPTION</u>
4	1692	.50" UNF High Hex Nut
8	1347	.50" UNF X 3.25" Capscrew
8	1351	.50"UNF X 4.50" Capscrew
1	54431	Left Tooth
1	54432	Right Tooth
2	54441	10" Chain Spacer
1	53058	10" Crumber Shoe
4	54439	8" Spacer
8	54440	Spacer Tube

4) FROM 10" WIDE TO 6" WIDE

<u>REQ'D</u>	<u>PART NO.</u>	<u>DESCRIPTION</u>
4	1340	.50" UNF X 1.50" Capscrew
1	53054	6" Crumber Shoe

5) FROM 8" WIDE TO 10" WIDE

<u>REQ'D</u>	<u>PART NO.</u>	<u>DESCRIPTION</u>
4	1692	.50" UNF High Hex Nut
8	1347	.50"UNF X 3.25" Capscrew
1	54431	Left Tooth
1	54432	Right Tooth
2	54441	10" Chain Spacer
1	53058	10" Crumber Shoe

6) FROM 10" WIDE TO 8" WIDE

<u>REQ'D</u>	<u>PART NO.</u>	<u>DESCRIPTION</u>
2	1340	.50" UNF X 1.50" Capscrew
2	1351	.50"UNF X 4.50" Capscrew
2	54440	Spacer Tube
1	54439	8" Spacer
1	53055	8" Crumber Shoe

CHAIN CONVERSIONS FOR 42" BOOMS - TOOTH EVERY OTHER STATION**1) FROM 6" WIDE TO 8" WIDE**

<u>REQ'D</u>	<u>PART NO.</u>	<u>DESCRIPTION</u>
12	1351	.50"UNF X 4.50" Capscrew
6	54439	8" Spacer
12	54440	Spacer Tube
1	53055	8" Crumber Shoe

2) FROM 8" WIDE TO 6" WIDE

<u>REQ'D</u>	<u>PART NO.</u>	<u>DESCRIPTION</u>
12	1340	.50" UNF X 1.50" Capscrew
1	53054	6" Crumber Shoe

DIGGING CHAIN OPTIONS**2.00" PITCH DIGGING CHAIN WIDTH CONVERSIONS****3) FROM 6" WIDE TO 10" WIDE**

<u>REQ'D</u>	<u>PART NO.</u>	<u>DESCRIPTION</u>
4	1692	.50" UNF High Hex Nut
8	1347	.50" UNF X 3.25" Capscrew
10	1351	.50"UNF X 4.50" Capscrew
1	54431	Left Tooth
2	54432	Right Tooth
2	54441	10" Chain Spacer
1	53058	10" Crumber Shoe
5	54439	8" Spacer
10	54440	Spacer Tube

4) FROM 10" WIDE TO 6" WIDE

<u>REQ'D</u>	<u>PART NO.</u>	<u>DESCRIPTION</u>
24	1340	.50" UNF X 1.50" Capscrew
1	53054	6" Crumber Shoe

5) FROM 8" WIDE TO 10" WIDE

<u>REQ'D</u>	<u>PART NO.</u>	<u>DESCRIPTION</u>
4	1692	.50" UNF High Hex Nut
8	1347	.50" UNF X 3.25" Capscrew
1	54431	Left Tooth
1	54432	Right Tooth
2	54441	10" Chain Spacer
1	53058	10" Crumber Shoe

6) FROM 10" WIDE TO 8" WIDE

<u>REQ'D</u>	<u>PART NO.</u>	<u>DESCRIPTION</u>
2	1340	.50" UNF X 1.50" Capscrew
14	1351	.50" UNF X 4.50" Capcrew
1	54439	8" Spacer
2	54440	Spacer Tube
1	53055	8" Crumber Shoe

CHAIN CONVERSIONS FOR 48" BOOMS - TOOTH EVERY OTHER STATION**1) FROM 6" WIDE TO 8" WIDE**

<u>REQ'D</u>	<u>PART NO.</u>	<u>DESCRIPTION</u>
12	1351	.50"UNF X 4.50" Capscrew
12	54440	Spacer Tube
6	54439	8" Spacer
1	53055	8" Crumber Shoe

2) FROM 8" WIDE TO 6" WIDE

<u>REQ'D</u>	<u>PART NO.</u>	<u>DESCRIPTION</u>
14	1340	.50" UNF X 1.50" Capscrew
1	53054	6" Crumber Shoe

MAINTENANCE

GENERAL MAINTENANCE

GENERAL INFORMATION

Your trencher was designed to be virtually maintenance free. Very little effort is needed to keep it in top condition. It is however important to follow these procedures to get full performance and longevity out of the trencher.

LUBRICATION

The only lubrication your trencher needs is the greasing of the headshaft end bearing. The bearing should be lubricated with an SAE multi-purpose grease every 8 hours of operation. A grease zerk is installed in the bearing to facilitate this task.

NOTE: Not all trenchers require lubricating of the headshaft bearing. Some units have a sealed bearing that requires no maintenance. These units can be identified by the absence of a grease zerk in the bearing.

IMPORTANT: DO NOT lubricate any other part of the trencher! Lubricating parts such as the digging chain or the idler wheel will only attract dirt, resulting in increased wear.

EVERY 40 HOURS OF OPERATION

Every 40 hours of operation the trencher should be inspected for loose nuts, capscrews, bearings etc. Tighten as required, replace where necessary. Clean equipment of all dirt, oil, grease, etc. This will assist you in making visual inspections and help avoid overlooking worn or damaged components. Keep all safety decals clean and legible. Replace if damaged or worn.

DIGGING TOOTH REPLACEMENT

Sharp teeth are important to good performance. When teeth wear out, production will drop sharply, increasing wear and tear on other components.

Cup teeth wear on the tip and side bulge in varying amounts. Wear patterns change with different digging conditions. The following patterns and captions are approximate and should be used as a guide to help you determine your own best cost/benefit tooth replacement time. Normal replacement should be made between 30% and 60% reduction in performance. Replacement is a bolt-on procedure. See Section J.



New	20% Reduced Performance	50% Reduced Performance	70% Reduced Performance	Beyond Use
				4445 3-3-92-2

STORAGE

625 TRENCHER

GENERAL INFORMATION

The following storage procedures will help you to keep your trencher in top condition. They will also help you get off to a good start the next time your trencher is needed. We therefore strongly recommend that you take the extra time to follow these procedures whenever your trencher will not be used for an extended period of time.

PREPARATION FOR STORAGE

1. Clean the trencher exterior thoroughly, removing all mud, dirt, and grease.
2. Tighten all loose bolts, nuts, and set screws.
3. Touch up unpainted and exposed areas with paint to prevent rust.
4. Coat the digging chain with a thin covering of oil. Operate chain for a short period to work the oil into the pins.
5. Store the trencher in a dry and protected place. Leaving the trencher outside, exposed to the elements will materially shorten its life.
6. Inspect trencher for visible signs of wear, breakage or damage. Order any parts required and make necessary repairs to avoid delays when starting next season.
7. Replace operating decals if damaged or in unreadable condition.

REMOVING FROM STORAGE

1. Remove all protective coverings
2. Check hydraulic hoses for deterioration and if necessary, replace.
3. During cold weather, operate the trencher slowly for a short time before placing the unit under full load.

TROUBLE SHOOTING

625 TRENCHER

GENERAL INFORMATION

Your trencher was designed to be as simple and as trouble free as possible. The purpose of this section is to help you in the event that a problem does develop. Why we cannot possibly cover every problem that might occur, you will find that those that are most common are covered here.

PROBLEM: Digging chain will not turn

POSSIBLE CAUSE AND REMEDY:

1. Quick coupler not completely engaged. Check to see that all couplers are matched pairs and engaged correctly. Check coupler hook-up information (See Section E) for proper hydraulic hose routing.
2. Quick coupler failure. Check couplers for dirt, rust, or other contaminants that could effect coupler engagement. Clean or replace couplers as needed.
3. Obstruction in hydraulic hose. Remove hydraulic hoses and couplers one at a time and check flow through hose by blowing through the hose or by pouring hydraulic fluid through the hose. Clean or replace hose as needed.
4. Skid steer relief valve stuck open. Have relief valve serviced and checked by an authorized dealer.
5. Skid steer auxiliary valve not operating properly. See skid steer operator's manual or dealer for information and help.
6. Hydraulic motor failed. Be sure you have hydraulic flow to the motor. If oil flow to motor is good, but motor will still not turn when detached from trencher headshaft, remove motor and have it serviced or replaced as needed.
7. Headshaft bearings failed. Inspect headshaft bearings for free movement. Check for binding or foreign matter jamming bearing. Clean or replace as necessary.
8. Boom end bearing failed. Inspect boom end bearing for free movement. Check for binding or foreign matter jamming bearing. Clean or replace as necessary.

TROUBLE SHOOTING

625 TRENCHER

9. Digging chain to tight. Digging chain should only be tight enough to remain on sprockets while turning under load. There should be some sag in the chain. If too tight, loosen chain by the adjusting nut(s) on the boom.
10. Sand build-up in tooth root of sprocket. Sand can build up in the sprockets effectively increasing the chain tension. Raise the boom out of the ditch and reverse the digging chain on the trencher, then run the trencher out of the trench to clear the sprockets. Reinstall the chain in its correct digging direction and readjust chain tension.
11. Digging sprocket clamp loose on headshaft. Observe if the headshaft is turning. If shaft is turning but sprocket is not, stop the trencher and tighten the sprocket clamp.

PROBLEM: Trencher does not dig fast enough

POSSIBLE CAUSE AND REMEDY:

1. Digging teeth worn. See maintenance Section L in this manual. Inspect teeth and replace as needed.
2. Skid steer relief valve set too low. See skid steer operator's manual and or dealer for proper relief valve service and adjustment.
3. Quick coupler or hose restriction. Inspect couplers and hoses for dirt, rust, and other contaminants and repair or replace as needed.
4. Hydraulic system over heating. Shut the trencher and skid steer down and allow oil to cool. Repeated stalling of the trencher will cause the oil to over heat. Avoid excessive stalling.
5. Cutting a ditch size beyond the ability of the skid steer. Your trencher is powered by oil from the skid steers auxiliary hydraulic system. The horsepower transmitted through the auxiliary hydraulics is substantially less than that of the engine.

PROBLEM: Hydraulic oil over heating

POSSIBLE CAUSE AND REMEDY:

1. Skid steer relief valve set too low. See skid steer operator's manual and/or dealer for proper relief valve service and adjustment.

TROUBLE SHOOTING

625 TRENCHER

2. Quick coupler or hose restriction. Inspect couplers and hoses for dirt, rust, and other contaminants and repair or replace as needed.
3. Motor or hose size not balanced to skid steer. A hose or a motor that is too small can cause added internal friction and resultant heat build-up. Check mounting kit parts list and diagram (See Section E) for proper hose size and type.
4. Skid steer not equipped with oil cooler or sufficient sump capacity. Check with your skid steer dealer for information and availability of auxiliary cooling and sump kits. Install if available. If not available stop skid steer and trencher and allow them to cool when they get too hot.



BOLT TORQUE

BOLT TORQUE SPECIFICATIONS

GENERAL TORQUE SPECIFICATION TABLE

Use the following torques when special torques are not given. These values apply to fasteners as received from suppliers, dry, or when lubricated with normal engine oil. They do not apply if special graphited or moly disulphide greases or other extreme pressure lubricants are used. This applies to both UNF and UNC threads. Remember to always use grade five or better when replacing bolts.

SAE Grade No.		2				5				8*			
Bolt head identification marks as per grade. NOTE: Manufacturing Marks Will Vary													
		TORQUE		TORQUE		TORQUE		TORQUE		TORQUE		TORQUE	
Bolt Size		Pounds Feet		Newton-Meters		Pounds Feet		Newton-Meters		Pounds Feet		Newton-Meters	
Inches	Millimeters	Min.	Max.	Min.	Max.	Min.	Max.	Min.	Max.	Min.	Max.	Min.	Max.
1/4	6.35	5	6	6.8	8.13	9	11	12.2	14.9	12	15	16.3	30.3
5/16	7.94	10	12	13.6	16.3	17	20.5	23.1	27.8	24	29	32.5	39.3
3/8	9.53	20	23	27.1	31.2	35	42	47.5	57.0	45	54	61.0	73.2
7/16	11.11	30	25	40.7	47.4	54	64	73.2	86.8	70	84	94.9	113.9
1/2	12.70	45	52	61.0	70.5	80	96	108.5	130.2	110	132	149.2	179.0
9/16	14.29	65	75	88.1	101.6	110	132	149.2	179.0	160	192	217.0	260.4
5/8	15.88	95	105	128.7	142.3	150	180	203.4	244.1	220	264	298.3	358.0
3/4	19.05	150	185	203.3	250.7	270	324	366.1	439.3	380	456	515.3	618.3
7/8	22.23	160	200	216.8	271.0	400	480	542.4	650.9	600	720	813.6	976.3
1	25.40	250	300	338.8	406.5	580	696	786.5	943.8	900	1080	1220.4	1464.5
1-1/8	25.58	-	-	-	-	800	880	1084.8	1193.3	1280	1440	1735.7	1952.6
1-1/4	31.75	-	-	-	-	1120	1240	1518.7	1681.4	1820	2000	2467.9	2712.0
1-3/8	34.93	-	-	-	-	1460	1680	1979.8	2278.1	2380	2720	3227.3	3688.3
1-1/2	38.10	-	-	-	-	1940	2200	2630.6	2983.2	3160	3560	4285.0	4827.4

* Thick Nuts must be used with Grade 8 bolts

METRIC BOLT TORQUE SPECIFICATIONS

Size of Screw	Grade No.	Coarse Thread			Fine Thread		
		Ptich (mm)	Pounds Feet	Newton-Meters	Pitch (mm)	Pounds Feet	Newton-Meters
M6	5.6	1.0	3.6-5.8	4.9-7.9	-	-	-
	8.8		5.8-9.4	7.9-12.7		-	-
	10.9		7.2-10	9.8-13.6		-	-
M8	5.6	1.25	7.2-14	9.8-19	1.0	12-17	16.3-23
	8.8		17-22	23-29.8		19-27	25.7-36.6
	10.9		20-26	27.1-35.2		22-31	29.8-42
M10	5.6	1.5	20-25	27.1-33.9	1.25	20-29	27.1-39.3
	8.8		34-40	46.1-54.2		35-47	47.4-63.7
	10.9		38-46	51.5-62.3		40-52	54.2-70.5
M12	5.6	1.75	28-34	37.9-46.1	1.25	31-41	42-55.6
	8.8		51-59	69.1-79.9		56-68	75.9-92.1
	10.9		57-66	77.2-89.4		62-75	84-101.6
M14	5.6	2.0	49-56	66.4-75.9	1.5	52-64	70.5-86.7
	8.8		81-93	109.8-126		90-106	122-143.6
	10.9		96-109	130.1-147.7		107-124	145-168
M16	5.6	2.0	67-77	90.8-104.3	1.5	69-83	93.5-112.5
	8.8		116-130	157.2-176.2		120-138	162.6-187
	10.9		129-145	174.8-196.5		140-158	189.7-214.1
M18	5.6	2.0	88-100	119.2-136	1.5	100-117	136-158.5
	8.8		150-168	203.3-227.6		177-199	239.8-269.6
	10.9		175-194	237.1-262.9		202-231	273.7-313
M20	5.6	2.5	108-130	146.3-176.2	1.5	132-150	178.9-203.3
	8.8		186-205	252-277.8		206-242	279.1-327.9
	10.9		213-249	288.6-337.4		246-289	333.3-391.6

SPECIFICATIONS

625 TRENCHER

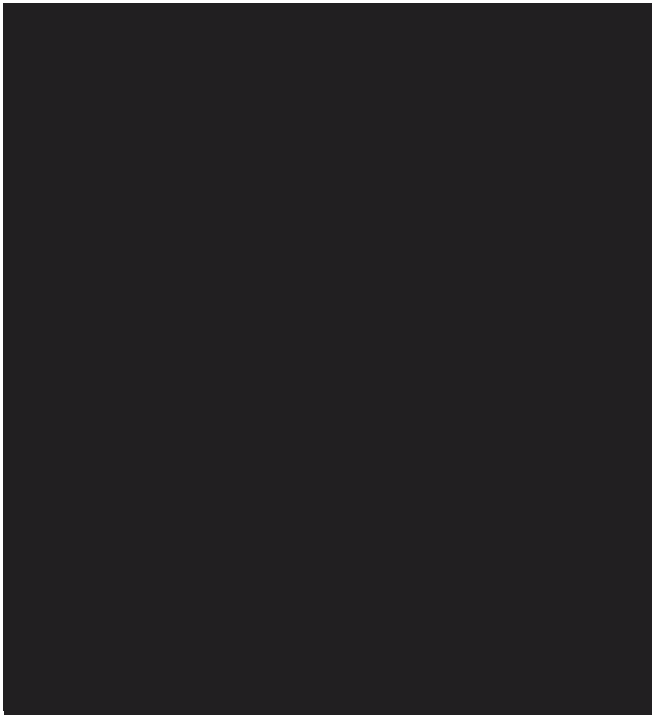

DESCRIPTION	BOOM SI E			
	0		2	8
	8	8	8	8
	10	10	10	-
	12	12	-	-
	8	8	8	8
			9	8
	2	2	2	2
	18	18	18	18
	1	1	1	1
	1	1	1	1
			1	22
			2000 -	000
				10 0
- 2	-	-		

DECALS

DECAL PLACEMENT 625 TRENCHER

GENERAL INFORMATION

The diagram on this page shows the location of all the decals used on the 625 trencher. The decals are identified by their part numbers, with reductions of the actual decals located on the following pages. Use this information to order replacements for lost or damaged decals. Be sure to read all decals before operating the trencher. They contain information you need to know for both safety and trencher longevity.

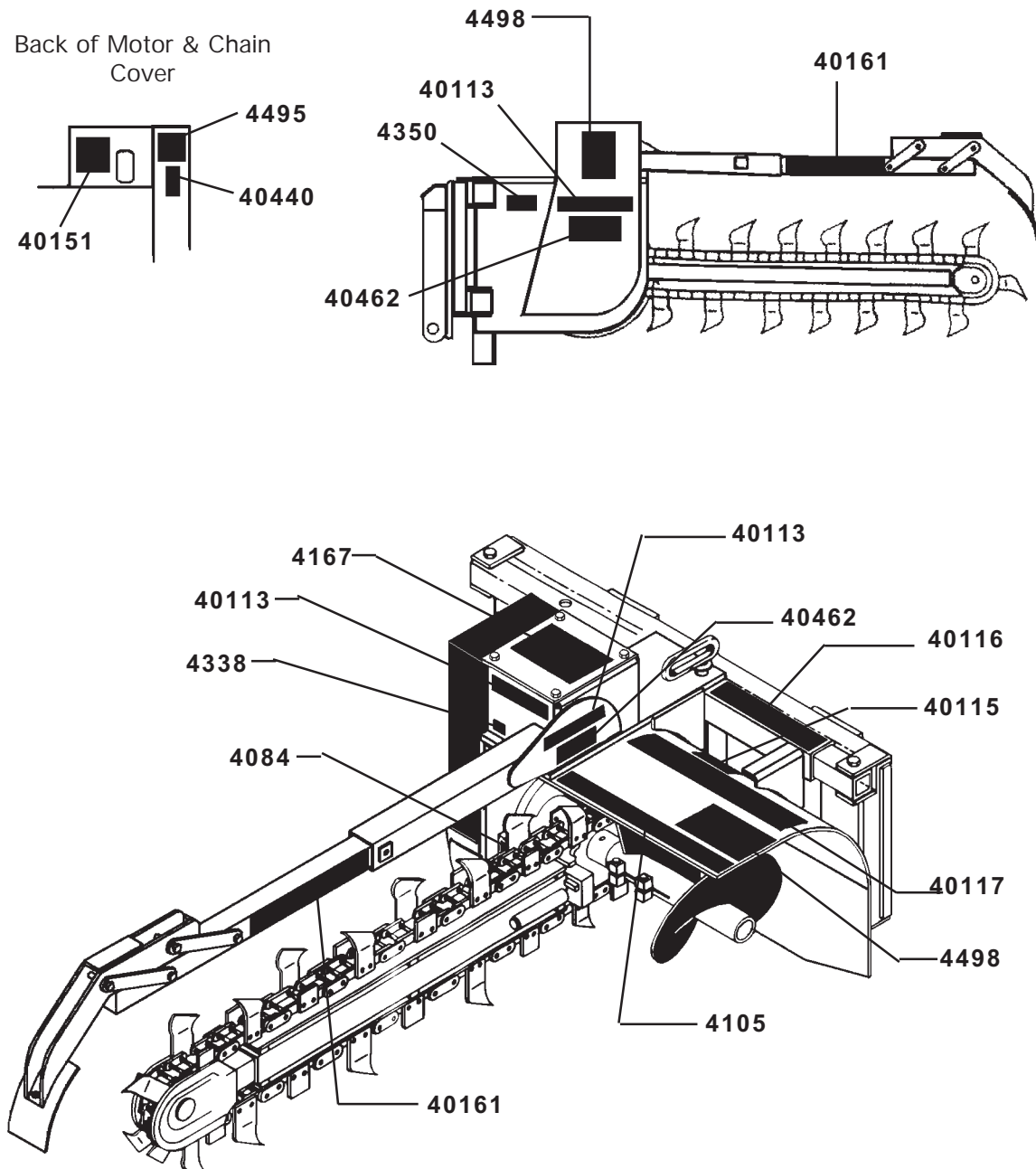

DECALS



PART #4167
NO STEP



PART #4498
DANGER!



PART #4495
WARNING! GUARDS



PART #4350
SERIAL NUMBER TAG

DECALS

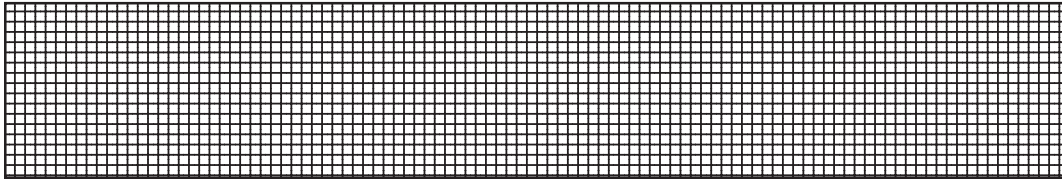

NON SLIP SURFACE DECAL
PART

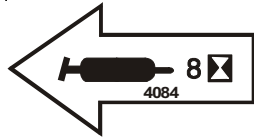

GREASE HOURS
PART



MADE IN USA
PART



WARNING HIGH PRESSURE FLUID
PART

MODEL NO.
PART

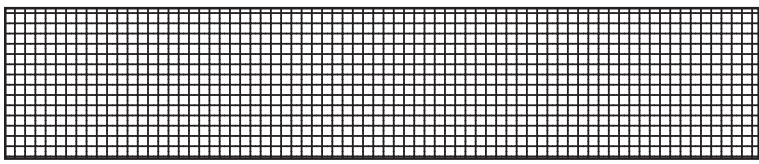

NON SLIP SURFACE DECAL
PART



BRADCO LOGO
PART



CALL BEFORE YOU DIG
PART

DECALS

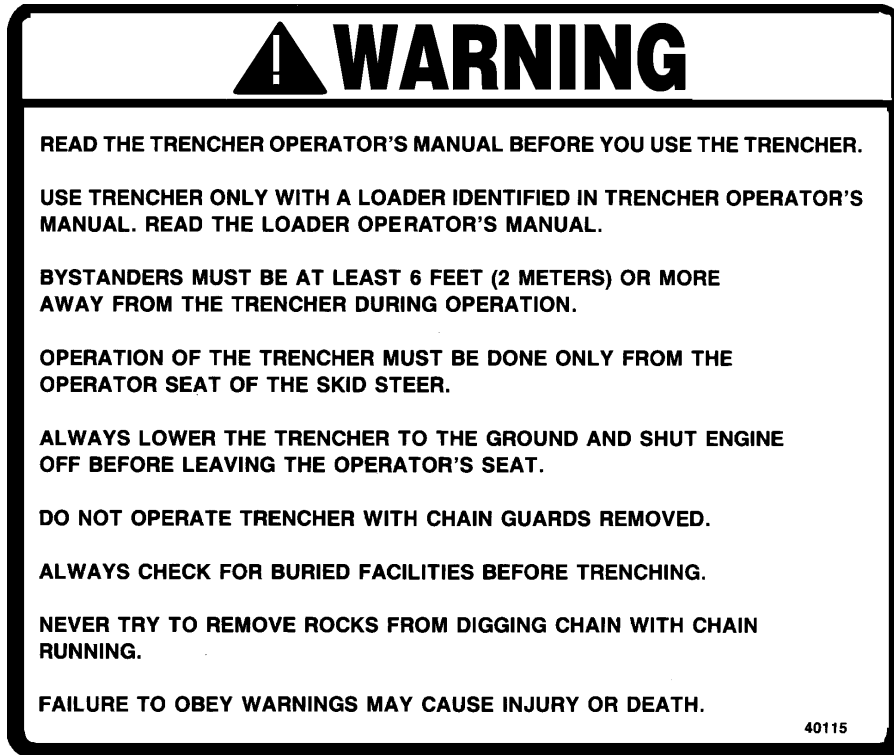

PART #40115
WARNING! GENERAL

DANGER STAND CLEAR

PART #4105
DANGER STAND CLEAR

STAND CLEAR

PART #40161
STAND CLEAR

PREDELIVERY CHECKLIST

625 TRENCHER

GENERAL INFORMATION

The following is a list of areas that should be inspected by the dealer prior to delivery of the trencher to the customer. The customer should check the list and make sure that the dealer has completed the inspection. Completion of this checklist will help insure that the customer receives the trencher in complete working order, ready to install.

PREDELIVERY CHECKLIST - CHECK AND ADJUST AS NECESSARY

1. _____ Check and lubricate trencher if necessary. See "Lubrication" Section H.
2. _____ Visually inspect the trencher for bent, loose, cracked, damaged or missing parts. Check for any other irregularities.
3. _____ Check all hydraulic connections for leaks and all hoses for proper positioning to reduce chafing and binding.
4. _____ Check the trencher's digging chain adjustment. See "Operating Instructions - Chain Tension Adjustment" Section G.
5. _____ Check trencher attachment bolts for tightness. Retighten after the first eight working hours, and after every forty working hour interval thereafter. See "Bolt Torque" Section O.
6. _____ Make sure decals are not damaged or missing and are in their correct location. See "Decals" Section Q.
7. _____ Complete and return the manufacturer's "Warranty Validation Form" and sign your dealership predelivery checklist.
8. _____ Operator to read the FIEI Trencher Safety Manual provided, before operating trencher.

LIMITED WARRANTY

EFFECTIVE ON PRODUCTS MANUFACTURED AFTER JANUARY 1, 2001

All new BRADCO products are warranted to be free from defects in materials or workmanship which may cause failure under normal usage and service when used for the purpose intended.

In the event of failure within twenty four (24) months from initial retail sale, lease or rental date (excluding cable, ground engaging parts such as sprockets, digging chain, bearings, teeth, tamping and demolition heads, blade cutting edges, pilot bits, auger teeth, auger heads & broom bristles), if after examination, BRADCO determines failure was due to defective material and/or workmanship, parts will be repaired or replaced. BRADCO may request defective part or parts be returned prepaid to them for inspection at their place of business at Delhi, Iowa, or to a location specified by BRADCO.

Any claims under this warranty must be made within fifteen (15) days after the Buyer learns of the facts upon which such claim is based. All claims not made in writing and received by BRADCO within the time period specified above shall be deemed waived.

THIS WARRANTY IS IN LIEU OF ALL OTHER WARRANTIES EXPRESSED OR IMPLIED AND THERE ARE NO WARRANTIES OF MERCHANTABILITY OR OF FITNESS FOR A PARTICULAR PURPOSE. IN NO EVENT SHALL BRADCO BE LIABLE FOR CONSEQUENTIAL OR SPECIAL DAMAGE.

BRADCO'S LIABILITY FOR ANY AND ALL LOSSES AND DAMAGES TO BUYER, RESULTING FROM ANY CAUSE WHATSOEVER, INCLUDING BRADCO'S NEGLIGENCE, IRRESPECTIVE OF WHETHER SUCH DEFECTS ARE DISCOVERABLE OR LATENT, SHALL IN NO EVENT EXCEED THE PURCHASE PRICE OF THE PARTICULAR PRODUCTS WITH RESPECT TO WHICH LOSSES OR DAMAGES ARE CLAIMED, OR, AT THE ELECTION OF BRADCO, THE REPAIR OR REPLACEMENT OF DEFECTIVE OR DAMAGED PRODUCTS.