



OPERATOR'S MANUAL

HYDRAULIC LATCH

for

KOMATSU



SERIAL NUMBER: _____

MODEL NUMBER: _____

Manual Number: OM699
Part Number: 75599
Rev. 3

TABLE OF CONTENTS

PREFACE	3
SAFETY PRECAUTIONS	
SAFETY STATEMENTS	5
GENERAL SAFETY PRECAUTIONS	5-7
DECALS	
DECAL PLACEMENT	8
DECALS	9
OPERATION	
GENERAL INFORMATION	10
CONNECTING TO AN ATTACHMENT	10
DISCONNECTING FROM ATTACHMENT	11
MAINTENANCE	
GENERAL INFORMATION	13
EVERY 8 HOURS	13
TROUBLESHOOTING	14
BOLT TORQUE SPECIFICATIONS	15
LIMITED WARRANTY	17

PREFACE

GENERAL COMMENTS

Congratulations on the purchase of your new BRADCO hydraulic latch! This product was carefully designed and manufactured to give you many years of dependable service. Only minor maintenance (such as cleaning and lubricating) is required to keep it in top working condition. Be sure to observe all safety precautions in this manual and on any safety decals located on the product and on any equipment on which the hydraulic latch is installed.

This manual has been designed to help you do a better, safer job. Read this manual carefully and become familiar with its contents.

WARNING! Never let anyone operate this unit without reading the "Safety Precautions" and "Operation Instructions" sections of this manual.



Always choose hard, level ground to park the vehicle on and set the brake so the unit cannot roll.

Unless noted otherwise, right and left sides are determined from the operator's control position facing forward.

NOTE: The illustrations and data used in this manual were current (according to the information available to us) at the time of printing, however, we reserve the right to redesign and change the attachment as may be necessary without notification.

BEFORE OPERATION

The primary responsibility for safety with this equipment falls to the operator. Make sure the equipment is operated only by trained individuals that have read and understand this manual. If there is any portion of this manual or function you do not understand, contact your local authorized dealer or the manufacturer.

SAFETY ALERT SYMBOL



This is the "Safety Alert Symbol" used by this industry. This symbol is used to warn of possible injury. Be sure to read all warnings carefully. They are included for your safety and for the safety of others working with you.

SERVICE

When servicing your product, remember to use only manufacturer replacement parts. Substitute parts may not meet the standards required for safe, dependable operation.

To facilitate parts ordering, record the model and serial number of your hydraulic latch kit in the space provided on the cover of this manual. This information may be obtained from the identification plate located on the rod extension of the hydraulic cylinder.

The parts department needs this information to insure that you receive the correct parts for your specific model.

SAFETY STATEMENTS



THIS SYMBOL BY ITSELF OR WITH A WARNING WORD THROUGHOUT THIS MANUAL IS USED TO CALL YOUR ATTENTION TO INSTRUCTIONS INVOLVING YOUR PERSONAL SAFETY OR THE SAFETY OF OTHERS. FAILURE TO FOLLOW THESE INSTRUCTIONS CAN RESULT IN INJURY OR DEATH.



DANGER

THIS SIGNAL WORD IS USED WHERE SERIOUS INJURY OR DEATH WILL RESULT IF THE INSTRUCTIONS ARE NOT FOLLOWED PROPERLY.



WARNING

THIS SIGNAL WORD IS USED WHERE SERIOUS INJURY OR DEATH COULD RESULT IF THE INSTRUCTIONS ARE NOT FOLLOWED PROPERLY.



CAUTION

THIS SIGNAL WORD IS USED WHERE MINOR INJURY COULD RESULT IF THE INSTRUCTIONS ARE NOT FOLLOWED PROPERLY.

NOTICE

NOTICE INDICATES A PROPERTY DAMAGE MESSAGE.

GENERAL SAFETY PRECAUTIONS

WARNING!

READ MANUAL PRIOR TO INSTALLATION



Improper installation, operation, or maintenance of this equipment could result in serious injury or death. Operators and maintenance personnel should read this manual, as well as all manuals related to this equipment and the prime mover thoroughly before beginning installation, operation, or maintenance. **FOLLOW ALL SAFETY INSTRUCTIONS IN THIS MANUAL AND THE PRIME MOVER'S MANUAL(S).**



READ AND UNDERSTAND ALL SAFETY STATEMENTS

Read all safety decals and safety statements in all manuals prior to operating or working on this equipment. Know and obey all OSHA regulations, local laws, and other professional guidelines for your operation. Know and follow good work practices when assembling, maintaining, repairing, mounting, removing, or operating this equipment.



KNOW YOUR EQUIPMENT

Know your equipment's capabilities, dimensions, and operations before operating. Visually inspect your equipment before you start, and never operate equipment that is not in proper working order with all safety devices intact. Check all hardware to ensure it is tight. Make certain that all locking pins, latches, and connection devices are properly installed and secured. Remove and replace any damaged, fatigued, or excessively worn parts. Make certain all safety decals are in place and are legible. Keep decals clean, and replace them if they become worn or hard to read.

GENERAL SAFETY PRECAUTIONS

WARNING!



PROTECT AGAINST FLYING DEBRIS

Always wear proper safety glasses, goggles, or a face shield when driving pins in or out, or when any operation causes dust, flying debris, or any other hazardous material.

WARNING!



LOWER OR SUPPORT RAISED EQUIPMENT

Do not work under raised booms without supporting them. Do not use support material made of concrete blocks, logs, buckets, barrels, or any other material that could suddenly collapse or shift positions. Make sure support material is solid, not decayed, warped, twisted, or tapered. Lower booms to ground level or on blocks. Lower booms and attachments to the ground before leaving the cab or operator's station.

WARNING!



USE CARE WITH HYDRAULIC FLUID PRESSURE

Hydraulic fluid under pressure can penetrate the skin and cause serious injury or death. Hydraulic leaks under pressure may not be visible. Before connecting or disconnecting hydraulic hoses, read your prime mover's operator's manual for detailed instructions on connecting and disconnecting hydraulic hoses or fittings.

- Keep unprotected body parts, such as face, eyes, and arms as far away as possible from a suspected leak. Flesh injected with hydraulic fluid may develop gangrene or other permanent disabilities.
- If injured by injected fluid, see a doctor at once. If your doctor is not familiar with this type of injury, ask him to research it immediately to determine proper treatment.
- Wear safety glasses, protective clothing, and use a piece of cardboard or wood when searching for hydraulic leaks. **DO NOT USE YOUR HANDS!** **SEE ILLUSTRATION.**

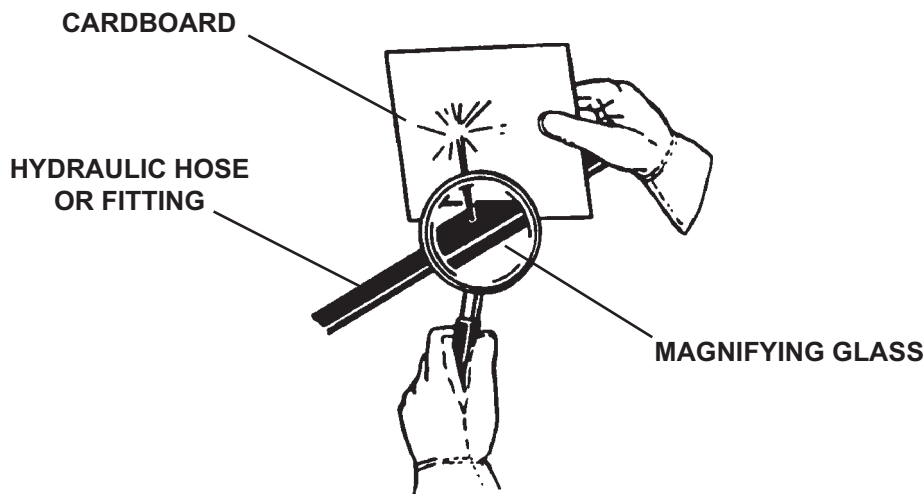

GENERAL SAFETY PRECAUTIONS

WARNING!



DO NOT MODIFY MACHINE OR ATTACHMENTS

Modifications may weaken the integrity of the attachment and may impair the function, safety, life, and performance of the attachment. When making repairs, use only the manufacturer's genuine parts, following authorized instructions. Other parts may be substandard in fit and quality. Never modify any ROPS (Roll Over Protection Structure) or FOPS (Falling Object Protective Structure) equipment or device. Any modifications must be authorized in writing by the manufacturer.

WARNING!



SAFELY MAINTAIN AND REPAIR EQUIPMENT

- Do not wear loose clothing or any accessories that can catch in moving parts. If you have long hair, cover or secure it so that it does not become entangled in the equipment.
- Work on a level surface in a well-lit area.
- Use properly grounded electrical outlets and tools.
- Use the correct tools for the job at hand. Make sure they are in good condition for the task required.
- Wear the protective equipment specified by the tool manufacturer.



SAFELY OPERATE EQUIPMENT

Do not operate equipment until you are completely trained by a qualified operator in how to use the controls, know its capabilities, dimensions, and all safety requirements. See your machine's manual for these instructions.

- Keep all step plates, grab bars, pedals, and controls free of dirt, grease, debris, and oil.
- Never allow anyone to be around the equipment when it is operating.
- Do not allow riders on the attachment or the prime mover.
- Do not operate the equipment from anywhere other than the correct operator's position with the seat belt fastened.
- Never leave equipment unattended with the engine running, or with an attachment in a raised position.
- Do not alter or remove any safety feature from the prime mover or any attachment.
- Know your work site safety rules as well as traffic rules and flow. When in doubt on any safety issue, contact your supervisor or safety coordinator for an explanation.

DECALS

DECAL PLACEMENT

GENERAL INFORMATION

The diagram on this page shows the location of the decals used on the BRADCO Hydraulic Latch. The decals are identified by their part numbers, with reductions of the actual decals located on the following pages. Use this information to order replacements for lost or damaged decals. Be sure to read all decals before operating the latch. They contain information you need to know for both safety and longevity.

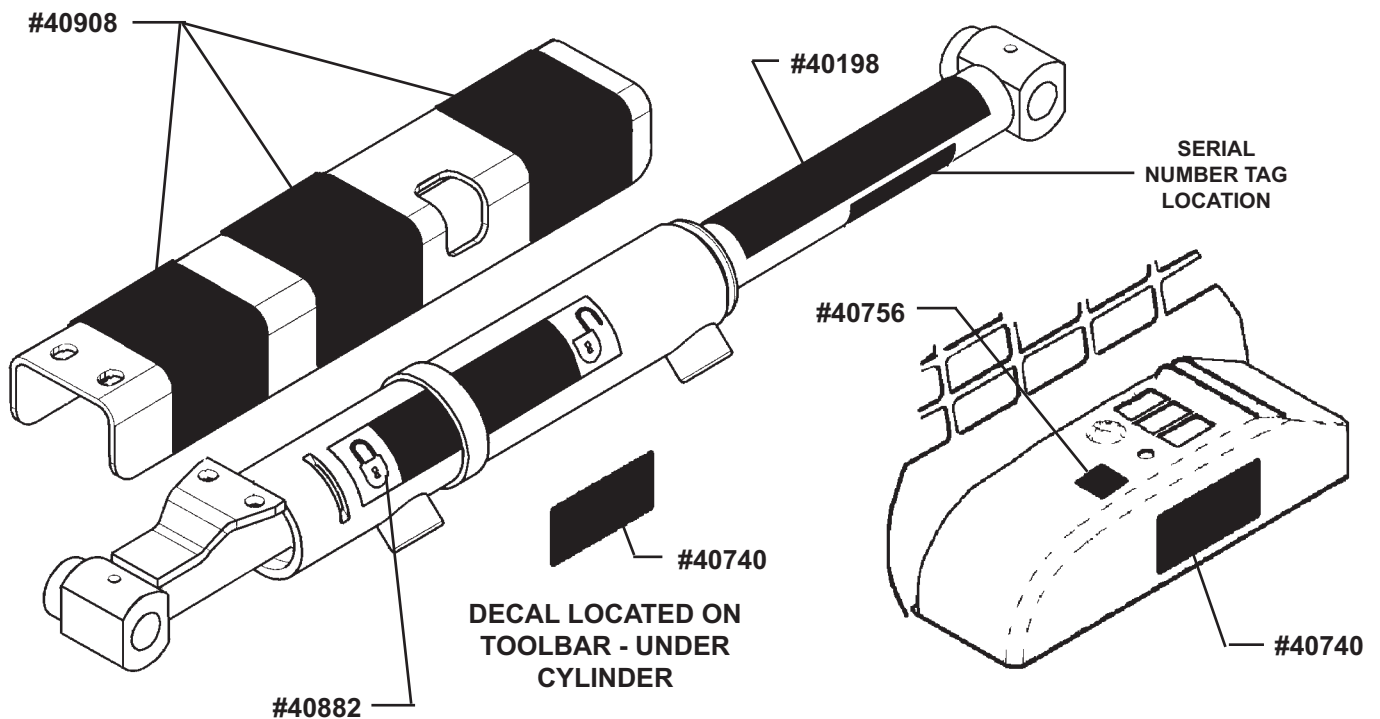

IMPORTANT: Keep all safety signs clean and legible. Replace all missing, illegible, or damaged safety signs. When replacing parts with safety signs attached, the safety signs must also be replaced.

REPLACING SAFETY SIGNS: Clean the area of application with nonflammable solvent, then wash the same area with soap and water. Allow the surface to fully dry. Remove the backing from the safety sign, exposing the adhesive surface. Apply the safety sign to the position shown in the diagram above and smooth out any bubbles.

DECALS

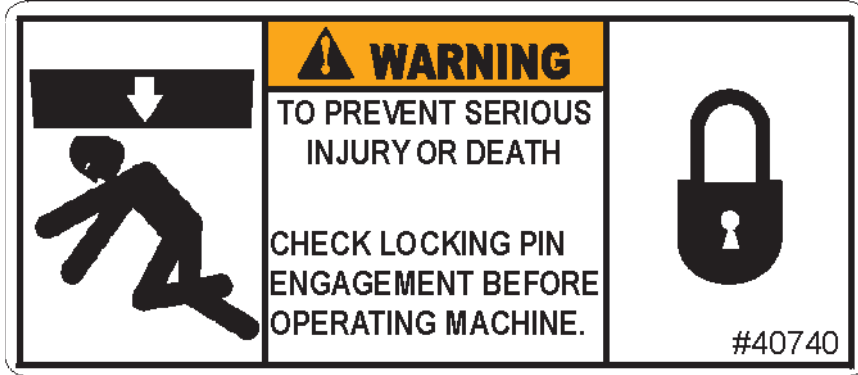

PART #40740 (2 REQUIRED)
WARNING (LOCATED ON TOOLBAR AND CONTROL PANEL)

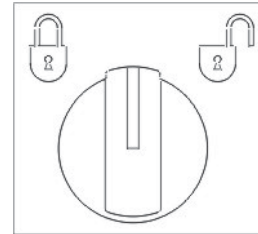

PART #40756
LOCK/UNLOCK
(LOCATED ON CONTROL PANEL)



PART #40882
LOCK / UNLOCK (LOCATED ON CYLINDER)



PART #40198
NON-SLIP SURFACE (LOCATED ON CYLINDER)



PART #40908 (3 REQUIRED)
NON-SLIP SURFACE (LOCATED ON CYLINDER GUARD)

OPERATION

GENERAL INFORMATION

The hydraulic latch assembly will operate only if the lock/unlock switch is turned while the toolbar, loader arms, or auxiliary hydraulic system is activated.

The hydraulic latch assembly is equipped with a “viewing window” that indicates whether the latch is in the locked or unlocked position.

The Yellow Unlocked symbol showing in the “viewing window” indicates that the lock pins are completely retracted and ready for either connecting or disconnecting an attachment.

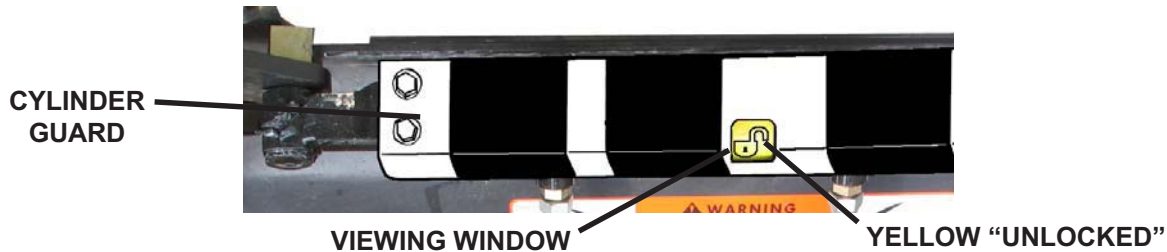

The Green “Locked” symbol showing in the “viewing window” indicates that the lock pins are completely extended, locking the attachment to the toolbar.



NOTE: Red showing through the “viewing window” indicates that the lock pins are neither completely extended or completely retracted. Do NOT operate any attachment unless the lock pins are completely extended and the GREEN “LOCKED” symbol is visible in the viewing window.

WARNING! Never operate lock switch unless locking or unlocking attachment.



Clear area of bystanders before operating the hydraulic latch.

NOTICE: Be sure latch area is clear of hoses, machinery and debris before operating.

CONNECTING TO ATTACHMENT

1. While seated in the operator’s seat, fasten the seat belt, lower the safety bar and start the engine. Roll back the toolbar against the stops and hold toolbar lever.

OPERATION

2. While holding the toolbar lever, turn rotary control switch to the “UNLOCKED” position and ensure that the yellow unlocked indicator is showing through the viewing window on the cylinder guard.

ROTARY CONTROL SWITCH



YELLOW “UNLOCKED” INDICATOR



3. Release the rotary control switch and the toolbar actuating lever. The latch is now “UNLOCKED” and ready to connect to the attachment.

WARNING! Keep the attachment and the toolbar as close to the ground as possible (within 2-3 inches) during all “LOCK” and “UNLOCK” operations.



4. Following all standard safety practices, incline the top of the toolbar forward and gradually approach the attachment while centering its retaining lip with the toolbar top edge. Slowly raise the arm and at the same time roll the top of the toolbar until it is completely engaged in the attachment.
5. Roll back the toolbar against the stops and hold toolbar lever.
6. While holding the toolbar lever, turn and hold rotary control switch to the “LOCKED” position and ensure that the green unlocked indicator is showing through the viewing window on the cylinder guard.

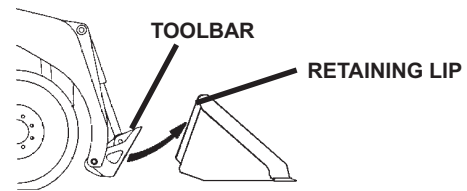

ROTARY CONTROL SWITCH



GREEN “LOCKED” INDICATOR



7. Release the rotary control switch and the toolbar actuating lever. The latch is now locked.
8. Following all standard safety practices and the instructions in your attachment or skid-steer operator’s manuals, complete any hydraulic connections (if required) on your attachment.

OPERATION

WARNING! To Avoid Serious Personal Injury, make sure both locking pins are completely engaged and that the attachment is securely latched to the toolbar. Failure to do so could result in separation of the attachment from the loader.



WARNING! NEVER operate the hydraulic latch lock/unlock rotary control switch while using the auxiliary hydraulics on an attachment. Operating the switch to the “UNLOCKED” position during attachment operation will result in separation of the attachment from the loader.



DISCONNECTING FROM ATTACHMENT

WARNING! Keep the attachment and the toolbar as close to the ground as possible (within 2-3 inches) during all “LOCK” and “UNLOCK” operations.



NOTICE: Be sure latch area is clear of hoses, machinery and debris before operating.

1. While seated in the operator’s seat, fasten the seat belt, lower the safety bar and start the engine. Roll back the toolbar against the stops and hold toolbar lever. Lower attachment to the ground and disconnect any hydraulic hoses from the loader auxiliary hydraulics.
2. Start skid steer loader, roll back the toolbar against the stops and hold toolbar lever.
3. While holding the toolbar lever, turn rotary control switch to the “UNLOCKED” position and ensure that the yellow unlocked indicator is showing through the viewing window on the cylinder guard.

ROTARY CONTROL SWITCH



YELLOW “UNLOCKED” INDICATOR

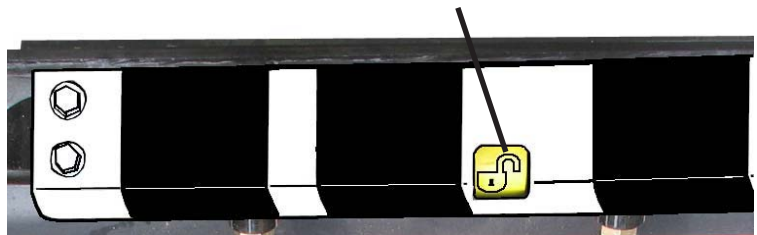

4. Release the rotary control switch and the toolbar actuating lever. The latch is now “UNLOCKED” and ready for disconnecting the attachment. Lower attachment to the ground.
5. Following all standard safety practices, gradually move in reverse while rotating the toolbar forward allowing the attachment retaining lip to slide off the top edge of the toolbar.

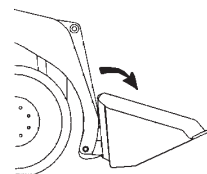

AFTER THE LATCH IS “UNLOCKED”, GRADUALLY MOVE IN REVERSE WHILE ROTATING THE TOOLBAR FORWARD.

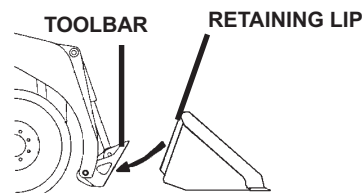

MAINTENANCE

GENERAL INFORMATION

Regular maintenance and service is the key to long equipment life and safe operation. Maintenance requirements have been kept to a minimum. However it is important that these maintenance procedures be performed as described in this section.

WARNING! Read the Safety Precautions section of this manual before performing any maintenance procedure.



Follow all mandatory safety shutdown procedures outlined in the loader operator's manual before adjusting, cleaning, lubricating or servicing this attachment.

EVERY 8 HOURS

Lubricate all pivot points.

Inspect linkage and adjust as required.

Check hydraulic hoses for leaks, pinching or deterioration.

Check all safety signs and lock indicator decals are clean and legible.

Replace any damaged or worn parts.

EVERY 2 YEARS OR 4000 HOURS (WHICHEVER OCCURS FIRST)

Replace all hydraulic hoses.

WARNING! Escaping hydraulic fluid under pressure can have sufficient force to penetrate the skin causing serious personal injury. Fluid escaping from a very small hole can be almost invisible. Use a piece of cardboard or wood rather than your hands to search for suspected leaks.



Keep unprotected body parts, such as face, eyes, and arms as far away as possible from a suspected leak. Flesh injected with hydraulic fluid may develop gangrene or other permanent disabilities.

If injured by injected fluid see a doctor at once. If your doctor is not familiar with this type of injury, ask him to research it immediately to determine proper treatment.

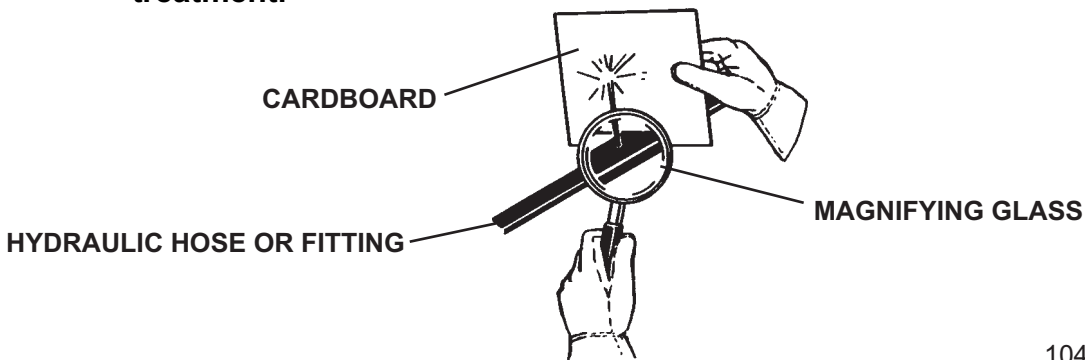

10423 11-23-05-2

TROUBLESHOOTING

PROBLEM	POSSIBLE CAUSE	REMEDY
Latch will not cycle	Air in hydraulic lines	Cycle lever to relieve air Bleed lines
	Toolbar not rolled back	Roll back toolbar and hold while cycling switch
	Latch linkage binding	Ensure links are properly installed Adjust linkage hardware Lubricate pivot points
Latch cycles reverse of switch decal	Valve wiring connected backward	Reverse DIN connectors at valve
Latch will unlock but will not lock, or will begin to lock but stops in the middle	Toolbar linkage out of adjustment	Adjust toolbar linkage



BOLT TORQUE

BOLT TORQUE SPECIFICATIONS

GENERAL TORQUE SPECIFICATION TABLE

Use the following torques when special torques are not given. These values apply to fasteners as received from suppliers, dry, or when lubricated with normal engine oil. They do not apply if special graphited or moly disulphide greases or other extreme pressure lubricants are used. This applies to both UNF and UNC threads. Remember to always use grade five or better when replacing bolts.

IMPORTANT: On all PLATED GRADE 8 bolts, reduce torque 15% from listed bolt torque specification.

SAE Grade No.		2				5				8*			
Bolt head identification marks as per grade. NOTE: Manufacturing Marks Will Vary													
		TORQUE		TORQUE		TORQUE		TORQUE		TORQUE		TORQUE	
Bolt Size		Pounds Feet		Newton-Meters		Pounds Feet		Newton-Meters		Pounds Feet		Newton-Meters	
Inches	Millimeters	Min.	Max.	Min.	Max.	Min.	Max.	Min.	Max.	Min.	Max.	Min.	Max.
1/4	6.35	5	6	7	8	9	11	12	15	12	15	16	20
5/16	7.94	10	12	14	16	17	20.5	23	28	24	29	33	39
3/8	9.53	20	23	27	31	35	42	48	57	45	54	61	73
7/16	11.11	30	35	41	47	54	64	73	87	70	84	95	114
1/2	12.70	45	52	61	70	80	96	109	130	110	132	149	179
9/16	14.29	65	75	88	102	110	132	149	179	160	192	217	260
5/8	15.88	95	105	129	142	150	180	203	244	220	264	298	358
3/4	19.05	150	185	203	251	270	324	366	439	380	456	515	618
7/8	22.23	160	200	217	271	400	480	542	651	600	720	814	976
1	25.40	250	300	339	406	580	696	787	944	900	1080	1220	1464
1-1/8	25.58	-	-	-	-	800	880	1085	1193	1280	1440	1736	1953
1-1/4	31.75	-	-	-	-	1120	1240	1519	1681	1820	2000	2468	2712
1-3/8	34.93	-	-	-	-	1460	1680	1980	2278	2380	2720	3227	3688
1-1/2	38.10	-	-	-	-	1940	2200	2631	2983	3160	3560	4285	4827

* Thick Nuts must be used with Grade 8 bolts

METRIC BOLT TORQUE SPECIFICATIONS

Size of Screw	Grade No.	Coarse Thread			Fine Thread		
		Ptich (mm)	Pounds Feet	Newton-Meters	Pitch (mm)	Pounds Feet	Newton-Meters
M6	5.6	1.0	3.6-5.8	4.9-7.9	-	-	-
	8.8		5.8-4	7.9-12.7		-	-
	10.9		7.2-10	9.8-13.6		-	-
M8	5.6	1.25	7.2-14	9.8-19	1.0	12-17	16.3-23
	8.8		17-22	23-29.8		19-27	25.7-36.6
	10.9		20-26	27.1-35.2		22-31	29.8-42
M10	5.6	1.5	20-25	27.1-33.9	1.25	20-29	27.1-39.3
	8.8		34-40	46.1-54.2		35-47	47.4-63.7
	10.9		38-46	51.5-62.3		40-52	54.2-70.5
M12	5.6	1.75	28-34	37.9-46.1	1.25	31-41	42-55.6
	8.8		51-59	69.1-79.9		56-68	75.9-92.1
	10.9		57-66	77.2-89.4		62-75	84-101.6
M14	5.6	2.0	49-56	66.4-75.9	1.5	52-64	70.5-86.7
	8.8		81-93	109.8-126		90-106	122-143.6
	10.9		96-109	130.1-147.7		107-124	145-168
M16	5.6	2.0	67-77	90.8-104.3	1.5	69-83	93.5-112.5
	8.8		116-130	157.2-176.2		120-138	162.6-187
	10.9		129-145	174.8-196.5		140-158	189.7-214.1
M18	5.6	2.0	88-100	119.2-136	1.5	100-117	136-158.5
	8.8		150-168	203.3-227.6		177-199	239.8-269.6
	10.9		175-194	237.1-262.9		202-231	273.7-313
M20	5.6	2.5	108-130	146.3-176.2	1.5	132-150	178.9-203.3
	8.8		186-205	252-277.8		206-242	279.1-327.9
	10.9		213-249	288.6-337.4		246-289	333.3-391.6

10360 6-8-95-2

LIMITED WARRANTY

All new Bradco products are warranted to be free from defects in materials or workmanship which may cause failure under normal usage and service when used for the purpose intended.

In the event of failure within twelve (12) months from initial retail sale, lease or rental date (excluding cable, ground engaging parts such as sprockets, digging chain, bearings, teeth, tamping and demolition heads, blade cutting edges, pilot bits, auger teeth, auger heads & broom bristles), if after examination, Bradco determines failure was due to defective material and/or workmanship, parts will be repaired or replaced. Bradco may request defective part or parts be returned prepaid to them for inspection at their place of business at Delhi, Iowa, or to a location specified by Bradco.

Any claims under this warranty must be made within fifteen (15) days after the Buyer learns of the facts upon which such claim is based. All claims not made in writing and received by Bradco within the time period specified above shall be deemed waived.

THIS WARRANTY IS IN LIEU OF ALL OTHER WARRANTIES EXPRESSED OR IMPLIED AND THERE ARE NO WARRANTIES OF MERCHANTABILITY OR OF FITNESS FOR A PARTICULAR PURPOSE. IN NO EVENT SHALL BRADCO BE LIABLE FOR CONSEQUENTIAL OR SPECIAL DAMAGE.

BRADCO'S LIABILITY FOR ANY AND ALL LOSSES AND DAMAGES TO BUYER, RESULTING FROM ANY CAUSE WHATSOEVER, INCLUDING BRADCO'S NEGLIGENCE, IRRESPECTIVE OF WHETHER SUCH DEFECTS ARE DISCOVERABLE OR LATENT, SHALL IN NO EVENT EXCEED THE PURCHASE PRICE OF THE PARTICULAR PRODUCTS WITH RESPECT TO WHICH LOSSES OR DAMAGES ARE CLAIMED, OR, AT THE ELECTION OF BRADCO, THE REPAIR OR REPLACEMENT OF DEFECTIVE OR DAMAGED PRODUCTS.